



LEYKOM®
supplying suppliers.



CATALOG

Sisteme de Afișare și Expunere

INDEX



World of display in jet speed

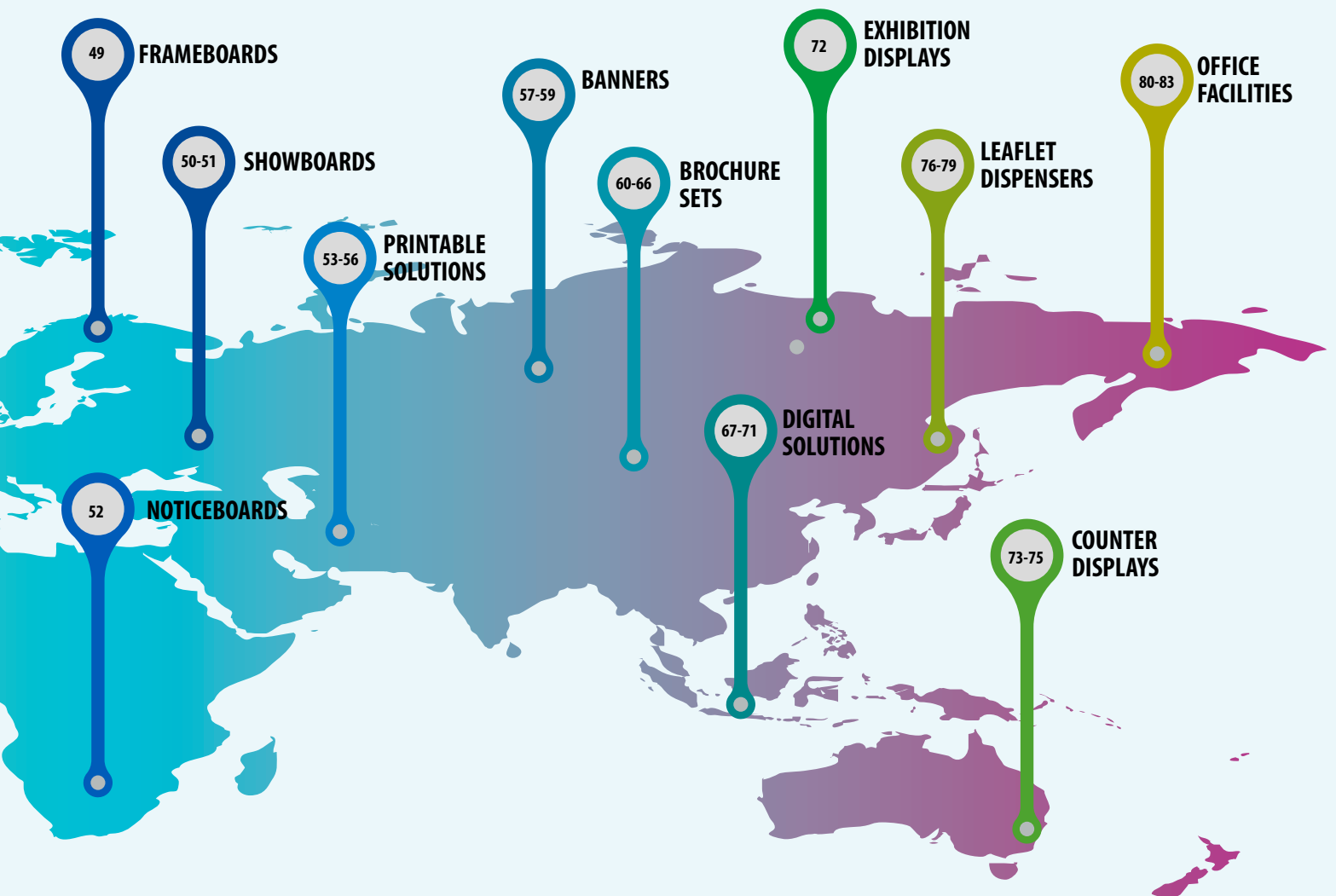



Opti Frame, a contemporary poster display system, is an innovative and patented snap frame. It provides multifunction in one produce. You can use the same unit on the wall or a counter in landscape or portrait positions. It can be used for signage needs of many locations; hotels, offices airports, stores, hospitals schools and many more.

Frame Colour

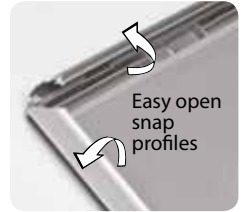
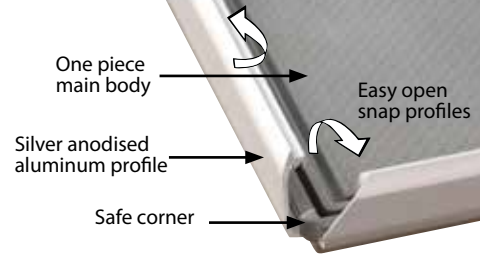

Profile Type

14 mm



25 mm

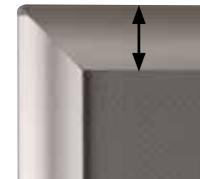

32 mm

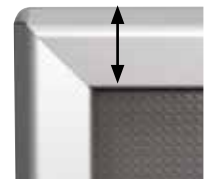

Smart design with distinctive features... "no sharp edges"

Optimised use! goes on counter, goes on wall...

Low cost snap frames with advanced design

Multi functional use

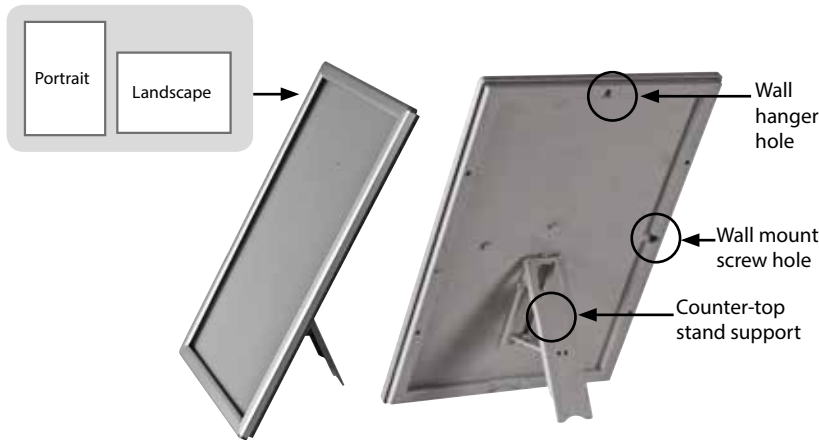

POSTER SIZE	PROFILE OPTIONS						Counter Support
	14 mm Profile		25 mm Profile		32 mm Profile		
	Mitred	Round	Mitred	Round	Mitred	Round	
A1	x	x	✓	✓	✓	✓	x
A2	x	x	✓	✓	x	x	x
A3	x	x	✓	✓	x	x	x
A4	✓	✓	✓	✓	x	x	✓
A5	✓	✓	x	x	x	x	✓
A6	✓	✓	x	x	x	x	✓
B2	x	x	✓	✓	✓	✓	x
5"X7"	✓	x	x	x	x	x	✓
8"X10"	✓	x	x	x	x	x	✓
8,5"X11"	x	x	✓	x	x	x	✓
11"X17"	x	x	✓	x	x	x	x
22"X 28"	x	x	✓	x	x	x	x

Opti Frame can be used for signage needs of many locations;

Patent: PCT/TR06/000018 - WO 2007/126397 - EP 2016574 - DE 20 2006 020 145 - US 2009/211 134 - AU 2006342800 - CN 101473363 - CA 2654307 - UA 2008 13893 - EA 200802174/26 - IN WO 2007/126397 - ZA 2008/09638 - TR 2007 05704 - OHIM 831235-0001,2,3,4

Opti Frame Family



A1 Mitred



B2 Mitred



A2 Mitred



A3 Mitred



A3 Round



A4 Mitred



A4 Round



A5 Mitred&Round



A6 Mitred&Round





Silver Round

Silver Mitred

Black

Wood

PROFILE : 14 mm 45° - 14 mm Round

MITREDSILVER	ROUND SILVER	BLACK	WOOD	POSTER	DESCRIPTION
UCP145N0A4	UCP140N0A4	-	-	210 X 297 mm	Without support
UCP145N1A4	UCP140N1A4	-	-	210 X 297 mm	With support
UCP145N000	-	-	-	203 X 254 mm	Without support
UCP145N100	-	-	-	203 X 254 mm	With support
UCP145N0A5	UCP140N0A5	UCP145B0A5	UCP145W0A5	148 X 210 mm	Without support
UCP145N0A6	UCP140N0A6	UCP145B0A6	UCP145W0A6	105 X 148 mm	Without support
UCP145N1A5	UCP140N1A5	UCP145B1A5	UCP145W1A5	148 X 210 mm	With support
UCP145N1A6	UCP140N1A6	UCP145B1A6	UCP145W1A6	105 X 148 mm	With support
UCP145N057	-	-	-	127 X 178 mm	Without support
UCP145N157	-	-	-	127 X 178 mm	With support



PROFILE : 25 mm 45° - 25 mm Round

MITRED SILVER	ROUND SILVER	BLACK	WOOD	POSTER	DESCRIPTION
UCP255N0B2	UCP250N0B2	-	-	500 X 700 mm	Without support
UCP255N0A1	UCP250N0A1	-	-	594 X 841 mm	Without support
UCP255N0A4	UCP250N0A4	UCP255B0A4	UCP255W0A4	210 X 297 mm	Without support
UCP255N1A4	UCP250N1A4	UCP255B1A4	UCP255W1A4	210 X 297 mm	With support
UCP255N0A3	UCP250N0A3	-	-	297 X 420 mm	Without support
UCP255N0A2	UCP250N0A2	-	-	420 X 594 mm	Without support
UCP255N022	-	UCP255B122	-	22" X 28"	Without support



PROFILE : 32 mm 45° - 32 mm Round

MITRED ARTICLE	ROUND ARTICLE	POSTER
UCP325N0B2	UCP320N0B2	500 X 700 mm
UCP325N0A1	UCP320N0A1	594 X 841 mm



PROFILE : 14 mm 45° - 14 mm Round

ARTICLE	COLOUR	POSTER
UCP145E1A4	RAL 6029-Green	210 X 297 mm
UCP145E1A5	RAL 6029-Green	148 X 210 mm
UCP145E1A6	RAL 6029-Green	105 X 148 mm
UCP145H1A4	RAL 9003-White	210 X 297 mm
UCP145H1A5	RAL 9003-White	148 X 210 mm
UCP145H1A6	RAL 9003-White	105 X 148 mm
UCP145L1A4	RAL 5002-Blue	210 X 297 mm
UCP145L1A5	RAL 5002-Blue	148 X 210 mm
UCP145L1A6	RAL 5002-Blue	105 X 148 mm
UCP145R1A4	RAL 3020-Red	210 X 297 mm
UCP145R1A5	RAL 3020-Red	148 X 210 mm
UCP145R1A6	RAL 3020-Red	105 X 148 mm
UCP145Y1A4	RAL 1021-Yellow	210 X 297 mm
UCP145Y1A5	RAL 1021-Yellow	148 X 210 mm
UCP145Y1A6	RAL 1021-Yellow	105 X 148 mm
UCP145B1A4	RAL 9005-Black	210 X 297 mm
UCP145B1A5	RAL 9005-Black	148 X 210 mm
UCP145B1A6	RAL 9005-Black	105 X 148 mm

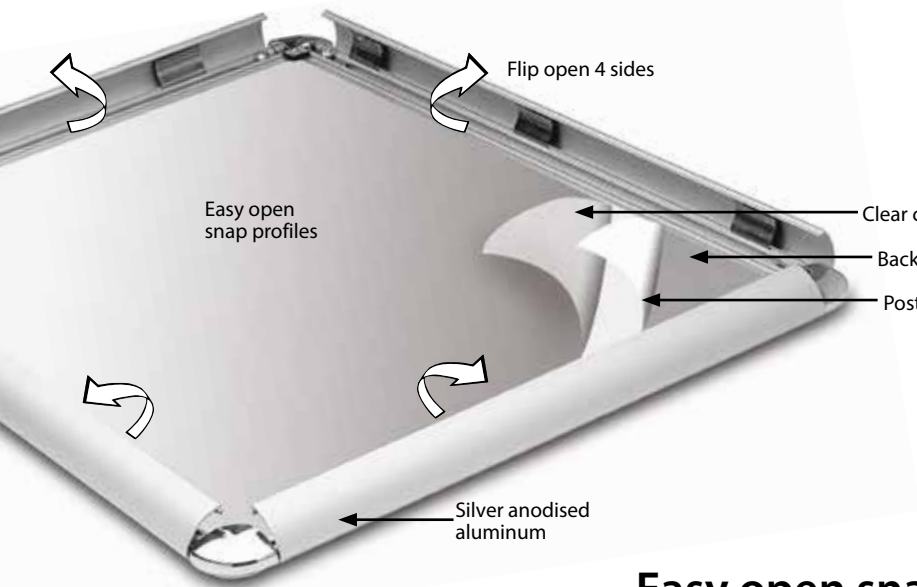

Large selection of Poster Frames are offered from 15mm to 46mm in mitred and round corners with different profile finishing such as silver, gold, chrome, black, wood and stainless. It is easy to change the poster with snap-open profiles. Profile is suitable for branding. Ready for wall mounting portrait or landscape. It provides professional solution for advertising in any trade area.

POSTER FRAMES

**Easy open snap profiles
Flip open 4 sides
Silver anodised aluminum
RAL colour available**

Profile Type

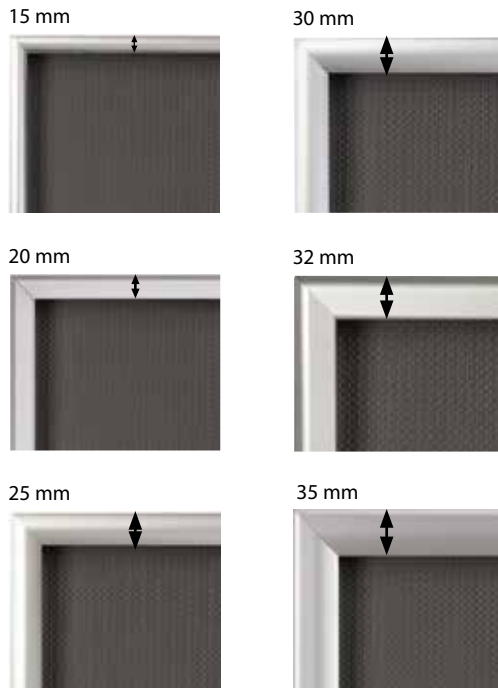

Corner Types



Frame Colour

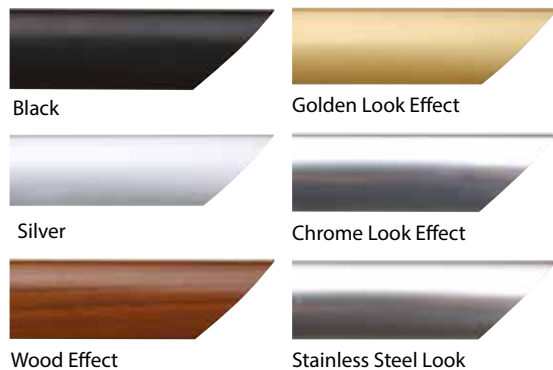

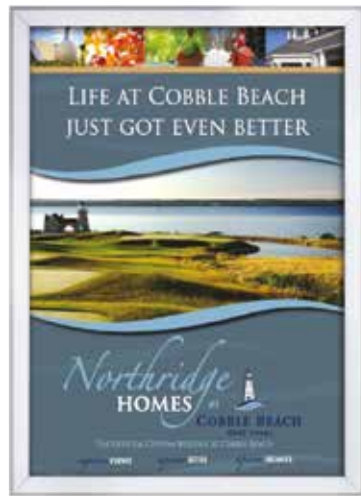

PROFILE : 15 mm 45°

ARTICLE	POSTER
UCN155NOA5	148 X 210 mm
UCN155NOA4	210 X 297 mm
UCN155NOA3	297 X 420 mm
UCN155NOA2	420 X 594 mm
UCN155NOA1	594 X 841 mm
UCN155NOB2	500 X 700 mm
UCN155NOB1	700 X 1000 mm
UCN155NO23	508 X 762 mm

PROFILE : 20 mm 45°

ARTICLE	POSTER
UCN205NOA4	210 X 297 mm
UCN205NOA3	297 X 420 mm
UCN205NOA2	420 X 594 mm
UCN205NOA1	594 X 841 mm
UCN205NOB2	500 X 700 mm
UCN205NOB1	700 X 1000 mm
UCN205NO23	508 X 762 mm
UCN205NO34	762 X 1016 mm

PROFILE : 25 mm 45° - 25 mm Round

GOLDEN	CHROME	STAINLESS	POSTER
UCN255GOA4	UCN255KOA4	UCN255SOA4	210 X 297 mm
UCN255GOA3	UCN255KOA3	UCN255SOA3	297 X 420 mm
UCN255GOA2	UCN255KOA2	UCN255SOA2	420 X 594 mm
UCN255GOA1	UCN255KOA1	UCN255SOA1	594 X 841 mm
UCN255GOB2	UCN255KOB2	UCN255SOB2	500 X 700 mm
UCN255GOB1	UCN255KOB1	UCN255SOB1	700 X 1000 mm
UCN255GO23	UCN255K023	UCN255SO23	508 X 762 mm
UCN255GO34	UCN255K034	UCN255SO34	762 X 1016 mm
UCN255GO46	UCN255K046	UCN255SO46	1016 X 1524 mm



PROFILE : 25 mm 45° - 25 mm Round

MITRE SILVER	ROUND SILVER	BLACK	WOOD	POSTER
UCN255NOA4	UCN250NOA4	UCN255BOA4	UCN255WOA4	210 X 297 mm
UCN255NOA3	UCN250NOA3	UCN255BOA3	UCN255WOA3	297 X 420 mm
UCN255NOA2	UCN250NOA2	UCN255BOA2	UCN255WOA2	420 X 594 mm
UCN255NOA1	UCN250NOA1	UCN255BOA1	UCN255WOA1	594 X 841 mm
UCN255NOB2	UCN250NOB2	UCN255BOB2	UCN255WOB2	500 X 700 mm
UCN255NOB1	UCN250NOB1	UCN255BOB1	UCN255WOB1	700 X 1000 mm
UCN255NO23	UCN250NO23	UCN255BO23	UCN255WO23	508 X 762 mm
UCN255NO34	UCN250NO34	UCN255BO34	UCN255WO34	762 X 1016 mm
UCN255NO46	UCN250NO46	UCN255BO46	UCN255WO46	1016 X 1524 mm



UYUP057000
Counter support
available. Suitable for
both landscape & portrait.

PROFILE : 30 mm 45° - 30 mm Round

MITRE SILVER	ROUND SILVER	POSTER
UCN305NOA4	UCN300NOA4	210 X 297 mm
UCN305NOA3	UCN300NOA3	297 X 420 mm
UCN305NOA2	UCN300NOA2	420 X 594 mm
UCN305NOA1	UCN300NOA1	594 X 841 mm
UCN305NOB2	UCN300NOB2	500 X 700 mm
UCN305NOB1	UCN300NOB1	700 X 1000 mm
UCN305NO23	UCN300NO23	508 X 762 mm
UCN305NO34	UCN300NO34	762 X 1016 mm
UCN305NO46	UCN300NO46	1016 X 1524 mm



PROFILE : 32 mm 45° - 32 mm Round

MITRED ARTICLE	ROUND ARTICLE	POSTER
UCN325NOA3	UCN320NOA3	297 X 420 mm
UCN325NOA2	UCN320NOA2	420 X 594 mm
UCN325NOA1	UCN320NOA1	594 X 841 mm
UCN325NOA0	UCN320NOA0	841 X 1189 mm
UCN325NOB2	UCN320NOB2	500 X 700 mm
UCN325NOB1	UCN320NOB1	700 X 1000 mm
UCN325NOB0	UCN320NOB0	1000 X 1400 mm
UCN325NO23	UCN320NO23	508 X 762 mm
UCN325NO34	UCN320NO34	762 X 1016 mm
UCN325NO46	UCN320NO46	1016 X 1524 mm

PROFILE : 45 mm 45°

ARTICLE	POSTER
UCN455NOA3	297 X 420 mm
UCN455NOA2	420 X 594 mm
UCN455NOA1	594 X 841 mm
UCN455NOA0	841 X 1189 mm
UCN455NOB2	500 X 700 mm
UCN455NOB1	700 X 1000 mm
UCN455NOB0	1000 X 1400 mm
UCN455NO23	508 X 762 mm
UCN455NO34	762 X 1016 mm
UCN455NO46	1016 X 1524 mm

PROFILE : 46 mm 45° - 46 mm Round

MITRED ARTICLE	ROUND ARTICLE	POSTER
UCN465NOA3	UCN460NOA3	297 X 420 mm
UCN465NOA2	UCN460NOA2	420 X 594 mm
UCN465NOA1	UCN460NOA1	594 X 841 mm
UCN465NOA0	UCN460NOA0	841 X 1189 mm
UCN465NOB2	UCN460NOB2	500 X 700 mm
UCN465NOB1	UCN460NOB1	700 X 1000 mm
UCN465NOB0	UCN460NOB0	1000 X 1400 mm
UCN465NO23	UCN460NO23	508 X 762 mm
UCN465NO34	UCN460NO34	762 X 1016 mm
UCN465NO46	UCN460NO46	1016 X 1524 mm

PROFILE : 38 mm 45°

ARTICLE	POSTER
UCN385NOA3	297 X 420 mm
UCN385NOA2	420 X 594 mm
UCN385NOA1	594 X 841 mm
UCN385NOA0	841 X 1189 mm
UCN385NOB2	500 X 700 mm
UCN385NOB1	700 X 1000 mm
UCN385NO23	508 X 762 mm
UCN385NO34	762 X 1016 mm



Safe edges

PROFILE : 32 mm Safe Corner

ARTICLE	POSTER
UCN321NOA3	297 X 420 mm
UCN321NOA2	420 X 594 mm
UCN321NOA1	594 X 841 mm
UCN321NOA0	841 X 1189 mm
UCN321NOB2	500 X 700 mm
UCN321NOB1	700 X 1000 mm
UCN321NOB0	1000 X 1400 mm
UCN321NO23	508 X 762 mm
UCN321NO34	762 X 1016 mm
UCN321NO46	1016 X 1524 mm

PROFILE : 40 mm 45°

ARTICLE	POSTER
UCF405NOA4	210 X 297 mm
UCF405NOA3	297 X 420 mm
UCF405NOA2	420 X 594 mm
UCF405NOA1	594 X 841 mm
UCF405NOA0	841 X 1189 mm
UCF405NOB2	500 X 700 mm
UCF405NOB1	700 X 1000 mm
UCF405NOB0	1000 X 1400 mm
UCF405NO23	508 X 762 mm
UCF405NO34	762 X 1016 mm
UCF405NO46	1016 X 1524 mm



Fancy Frame, with a snap open design, is a simple to use framing system that makes changing graphics easy. The Fancy Frames are in different sizes and fits in decorative use of picture frames serving the needs of advertisers and decorators. These clip frames differ from conventional snap frame designs due to the decorative form. This decorative design catches viewer's attention on the displayed advertisements. Having a more stylish design than traditional models, these picture frames will capture the eyes within any commercial environment. Suitable to use in shops, retail stores, restaurants, hotel receptions, banks and waiting areas. Anti-glare poster cover sheet.

FANCY FRAME

2 colours in 1 frame

Paper boards is a snap open design, paper holder. Suitable for indoor use and in portrait position. Provided with 2 clear plastic clips for each paper, one product can present 4x A4, 6x A4 or 9x A4 options. 2 colour presence serve different needs & design of environment. Paperboard is suitable for office use, as announcement boards, schools, markets and hospitals. Anti-glare poster cover sheet.

PAPER BOARD



Outer profiles black, inner profiles silver

Outer profiles silver, inner profiles black



PROFILE : 40 mm 45°		
ARTICLE	CAPACITY	DESCRIPTION
UPB405BN04	4 X A4	Black- Silver
UPB405BN06	6 X A4	Black- Silver
UPB405BN09	9 X A4	Black- Silver
UPB405NB04	4 X A4	Silver-Black
UPB405NB06	6 X A4	Silver-Black
UPB405NB09	9 X A4	Silver-Black



Outer profiles silver, inner profiles black

Outer profiles black, inner profiles silver

PROFILE : 40 mm 45°		
BLACK-SILVER	SILVER-BLACK	POSTER
UCC405BNA4	UCC405NBA4	210 X 297 mm
UCC405BNA3	UCC405NBA3	297 X 420 mm
UCC405BNA2	UCC405NBA2	420 X 594 mm
UCC405BNA1	UCC405NBA1	594 X 841 mm
UCC405BNA0	UCC405NBA0	841 X 1189 mm
UCC405BNB2	UCC405NBB2	500 X 700 mm
UCC405BNB1	UCC405NBB1	700 X 1000 mm
UCC405BN23	UCC405NB23	508 X 762 mm
UCC405BN34	UCC405NB34	1000 X 1400 mm



2 colours in 1 frame

Double colour frame is a snap open design, provided with 2 colour presence. Corporate colours, aesthetic appearance, contrast concepts highlight the product for various applications. Double colour frame in different sizes serve different needs & projects of advertisers and decorators. Having a more stylish design & 2 colour presence, different then traditional models, capture the eyes within any commercial environment. Anti-glare poster cover sheet.

DOUBLE COLOUR FRAME

- Ideal for medium-sized posters
- It is a secure hard-to-open profile.
- Suitable for open-air use or highly frequented areas accessible to the public.
- Natural Silver-anodized and various RAL colors are available.
- Anti-glare poster cover sheet.

SECURITY FRAMES

PROFILE : 40 mm 45°		
25 mm	42 mm	POSTER
UCZ255N0A4	-	210 X 297 mm
UCZ255N0A3	UCZ425N0A3	297 X 420 mm
UCZ255N0A2	UCZ425N0A2	420 X 594 mm
UCZ255N0A1	UCZ425N0A1	594 X 841 mm
-	UCZ425N0A0	841 X 1189 mm
UCZ255N0B2	UCZ425N0B2	500 X 700 mm
UCZ255N0B1	UCZ425N0B1	700 X 1000 mm
-	-	1000 X 1400 mm
UCZ255N023	UCZ425N023	508 X 762 mm
UCZ255N034	UCZ425N034	762 X 1016 mm
UCZ255N046	UCZ425N046	1016 X 1524 mm



Security system



Levertool to open the security profiles is sold separately. Please don't forget to order.



25 mm

42 mm



UYUP047100
Levertool for 42 mm



UYUP047000
Levertool for 25 mm



The Window Frame system is available in 25 mm profile. You can easily change the poster by opening the front profile. 2 anti-reflex PET covers use, poster can be displayed both indoor & outdoor. The system includes decorative back profile to hide the double-sided adhesive tape which holds the frame to the window. Anti-glare poster cover sheet.

WINDOW FRAMES

PROFILE : 25 mm 45° - 32 mm 45°

25 mm	32 mm	POSTER
UCW255N4A4	UCW325N4A4	210 X 297 mm
UCW255N4A3	UCW325N4A3	297 X 420 mm
UCW255N4A2	UCW325N4A2	420 X 594 mm
UCW255N4A1	UCW325N4A1	594 X 841 mm
-	UCW325N4A0	841 X 1189 mm
UCW255N4B2	UCW325N4B2	500 X 700 mm
UCW255N4B1	UCW325N4B1	700 X 1000 mm
-	UCW325N4B0	1000 X 1400 mm
UCW255N423	UCW325N423	508 X 762 mm
UCW255N434	UCW325N434	762 X 1016 mm
UCW255N446	UCW325N446	1016 X 1524 mm



25 mm



32 mm



Double-sided tape on the back frame



Decorative profile application



Plastic injected Window Sign is a practical solution for places where messages changes very often. It is suitable for posters printed double sided or 2 posters printed in single sided. Matching decorative profiles complete the view from outside the window. Available in Black and Grey as standard. Anti-glare poster cover sheet.

WINDOW SIGN

7 mm depth



Patent OHIM DM/084 128

Magnets

Magnets



Hinge

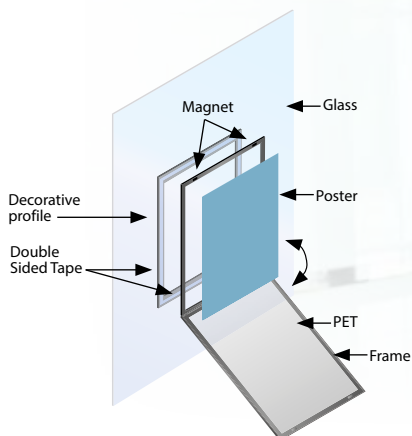

MATERIAL: Plastic injected

ARTICLE	POSTER	DESCRIPTION
UCWP10B0A4	210 X 297 mm	Magnetic / Ral 9005
UCWP10N0A4	210 X 297 mm	Magnetic / Ral 9006



The lockable Window Frame system is available in a 32 mm profile. Thanks to 2 anti-reflex PET covers, your posters can be displayed both indoor & outdoor. The system includes a decorative back profile to hide the double-sided adhesive tape holding the frame up to the window. As the tape surrounds the whole frame, it prevents any water flow from the outside in order to keep your poster dry. The profiles open sequentially and the lockable system ensures your poster is never accessed by unauthorized third parties. Antiglare poster cover sheet.

PROFILE : 32 mm 45°

ARTICLE	POSTER
UCK325N4A4	210 X 297 mm
UCK325N4A3	297 X 420 mm
UCK325N4A2	420 X 594 mm
UCK325N4A1	594 X 841 mm
UCK325N4A0	841 X 1189 mm
UCK325N4B2	500 X 700 mm
UCK325N4B1	700 X 1000 mm
UCK325N4B0	1000 X 1400 mm
UCK325N423	508 X 762 mm
UCK325N434	762 X 1016 mm
UCK325N446	1016 X 1524 mm

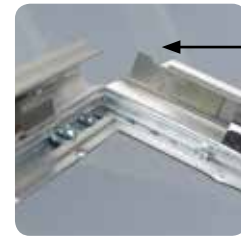

Interior corner lock component



Locking frame with allen key

LOCKABLE WINDOW FRAME

Interior corner lock component



Locking frame with allen key



PROFILE : 32 mm 45°

ARTICLE	POSTER
UCL325N0A4	210 X 297 mm
UCL325N0A3	297 X 420 mm
UCL325N0A2	420 X 594 mm
UCL325N0A1	594 X 841 mm
UCL325N0A0	841 X 1189 mm
UCL325N0B2	500 X 700 mm
UCL325N0B1	700 X 1000 mm
UCL325N0B0	1000 X 1400 mm
UCL325N023	508 X 762 mm
UCL325N034	762 X 1016 mm
UCL325N046	1016 X 1524 mm

The four sides of the lockable frame open sequentially. The last profile is held in place with a screw on top that can be opened with its key. This system ensures your poster is never accessed by unauthorized third parties. Anti glare poster cover sheet.

LOCKABLE SNAP FRAME



- Fire classified for EN13501-1 Class B s1 d0, hardly inflammable
- 25mm wide silver anodised profile with mitred corners.
- Veralite fire resistant anti-reflex poster protection.
- Perfect for educational, commercial and public places.



PROFILE : 25 mm 45°

ARTICLE	POSTER
UCFR255NA4	210 X 297 mm
UCFR255NA3	297 X 420 mm
UCFR255NA2	420 X 594 mm
UCFR255NA1	594 X 841 mm
UCFR255NA0	841 X 1189 mm
UCFR255NB2	500 X 700 mm
UCFR255NB1	700 X 1000 mm
UCFR255NB0	1000 X 1400 mm



FIRE RESISTANT SNAP FRAME



IP55 APPROVED



- Suitable for use under outdoor conditions.
- Ideal for poster of every size.
- Natural Silver-anodized with different available in RAL colors.
- Mitred corners.
- There are water drainage holes on the product (for details see assembly sheet).
- Anti-glare poster cover sheet.

WEATHERPROOF FRAMES



PROFILE : 25 mm 45° - 35 mm 45°

25 mm	35 mm	POSTER
UCH255N0A4	UCH355N0A4	210 X 297 mm
UCH255N0A3	UCH355N0A3	297 X 420 mm
UCH255N0A2	UCH355N0A2	420 X 594 mm
UCH255N0A1	UCH355N0A1	594 X 841 mm
-	UCH355N0A0	841 X 1189 mm
UCH255N0B2	UCH355N0B2	500 X 700 mm
UCH255N0B1	UCH355N0B1	700 X 1000 mm
-	UCH355N0B0	100 X 1400 mm
UCH255N023	UCH355N023	508 X 762 mm
UCH255N034	UCH355N034	762 X 1016 mm
-	UCH355N046	1016 X 1524 mm

LOCKABLE PROFILE : 35 mm 45°

ARTICLE	POSTER
UCV355N0A4	210 X 297 mm
UCV355N0A3	297 X 420 mm
UCV355N0A2	420 X 594 mm
UCV355N0A1	594 X 841 mm
UCV355N0A0	841 X 1189 mm
UCV355N0B2	500 X 700 mm
UCV355N0B1	700 X 1000 mm
UCV355N0B0	1000 X 1400 mm
UCV355N023	508 X 762 mm
UCV355N034	762 X 1016 mm
UCV355N046	1016 X 1524 mm

25 mm

Patent
TR 2006 06254
PCT/TR06/000064

35 mm

Lockable 35 mm



Locking frame with allen key



Sealing rubber

Water drainage holes

Optional accessories



Free hanging hook, comes with frames in standard.



Ceiling hangers are optional.



A suitable way to present your messages and posters in spaces where you have no wall mounting possibilities. If suspended from the ceiling via wire cables in front of shop windows, the posters can be viewed both from the inside and from the outside. Anti glare poster cover sheet.

DOUBLE SIDED SNAP FRAMES

PROFILE : 25 mm 45°

MITRED 25 mm	POSTER
UCD255N2A4	210 X 297 mm
UCD255N2A3	297 X 420 mm
UCD255N2A2	420 X 594 mm
UCD255N2A1	594 X 841 mm
-	840 X 1189 mm
UCD255N2B2	500 X 700 mm
UCD255N2B1	700 X 1000 mm
UCD255N223	508 X 762 mm
UCD255N234	762 X 1016 mm
UCD255N246	1016 X 1524 mm



Optional accessories



UYAA001100

UYAA007000

UYAA006000

UYAA001000

UYAA002100

UYAA002200

UYAA000000

UYAA004000

UYAA005000



A poster frame with magnetic cover brings new style to frames. It is very slim and elegant and different than most frames available. Can be used landscape or portrait.

MAGNETIC FRAME

Single Sided

MATERIAL : Silver anodised aluminium			
SILVER	BLACK	POSTER	DESCRIPTION
UCMONTB0A4	UCMOBTB0A4	210 X 297 mm	Landscape-Portrait
UCMONTB0A3	UCMOBTB0A3	297 X 420 mm	Landscape-Portrait
UCMONTB0A2	UCMOBTB0A2	420 X 594 mm	Landscape-Portrait
UCMONTB0A1	UCMOBTB0A1	594 X 841 mm	Landscape-Portrait
UCMONTB0A0	UCMOBTB0A0	841 X 1189 mm	Landscape-Portrait
UCMONTB0B2	UCMOBTB0B2	500 X 700 mm	Landscape-Portrait
UCMONTB0B1	UCMOBTB0B1	700 X 1000 mm	Landscape-Portrait
UCMONTB023	UCMOBTB023	508 X 762 mm	Landscape-Portrait
UCMONTB034	UCMOBTB034	762 X 1016 mm	Landscape-Portrait

Double Sided

MATERIAL : Silver anodised aluminium			
SILVER	BLACK	POSTER	DESCRIPTION
UCMONCB0A4	UCMOBCB0A4	210 X 297 mm	Landscape-Portrait
UCMONCB0A3	UCMOBCB0A3	297 X 420 mm	Landscape-Portrait
UCMONCB0A2	UCMOBCB0A2	420 X 594 mm	Landscape-Portrait
UCMONCB0A1	UCMOBCB0A1	594 X 841 mm	Landscape-Portrait
UCMONCB0A0	UCMOBCB0A0	841 X 1189 mm	Landscape-Portrait
UCMONCB0B2	UCMOBCB0B2	500 X 700 mm	Landscape-Portrait
UCMONCB0B1	UCMOBCB0B1	700 X 1000 mm	Landscape-Portrait
UCMONCB023	UCMOBCB023	508 X 762 mm	Landscape-Portrait
UCMONCB034	UCMOBCB034	762 X 1016 mm	Landscape-Portrait



Single Sided Portrait



Single Sided Landscape



2 wall hangers are standard in each product. Moving hangers let the mounting in Portrait and Landscape position.

Suitable for use in landscape and portrait positions.

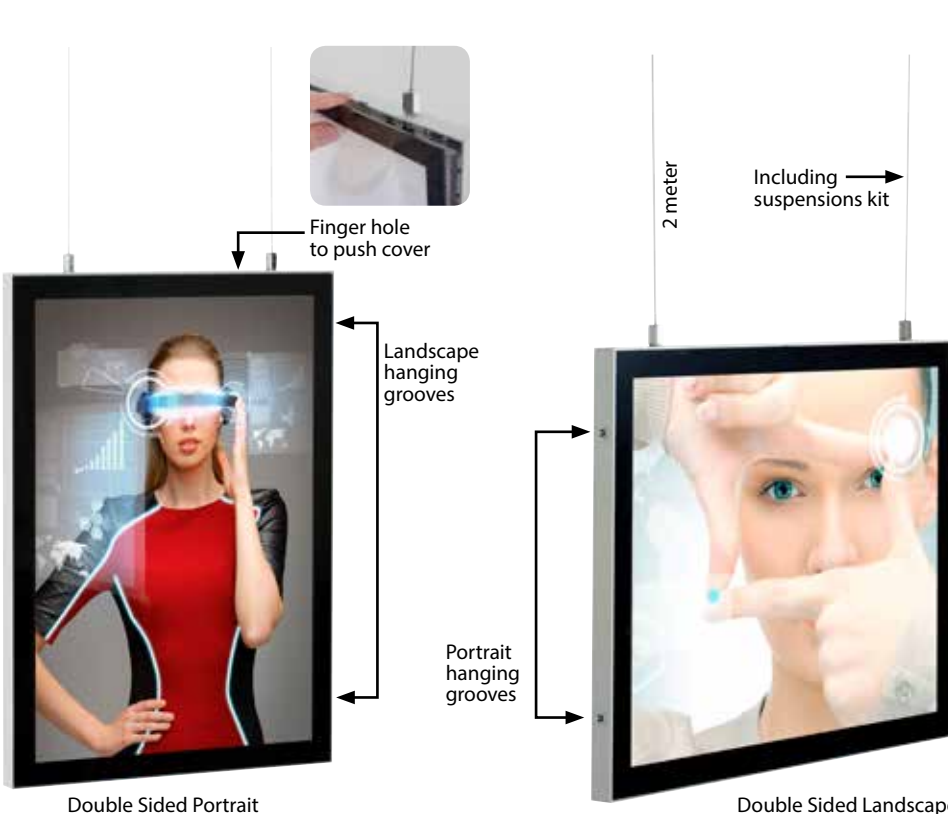

Double Sided Portrait

Double Sided Landscape





Slide-in frames are practical to change posters by sliding them in & out. Ready for use with 2 PET covers. It has single and double sided options as well as counter options. It is recommended for shops, petrol stations, offices, hotels, travel agents and similar trade area.

SLIDE-IN FRAMES



A5 Size Portrait



Double sided tape



A4 Size Landscape

Counter

MATERIAL : Silver anodised aluminium		
LANDSCAPE	PORTRAIT	POSTER
UCA255N2A5	UCA255N1A5	210 X 148 mm
UCA255N2A4	UCA255N1A4	297 X 210 mm
UCA255N2A3	UCA255N1A3	420 X 297 mm

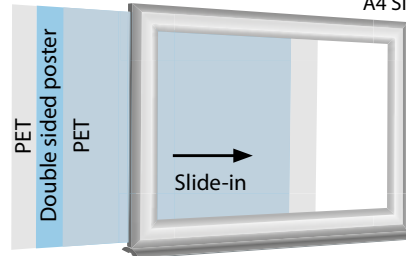

Portrait

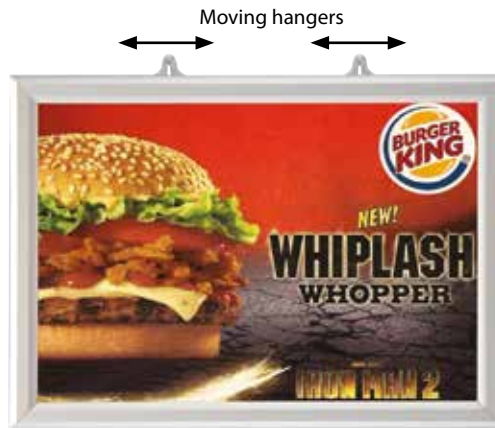

Landscape

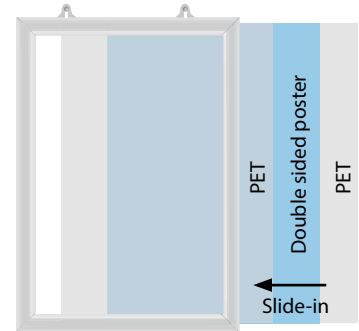

Double Sided

MATERIAL : Silver anodised aluminium		
PORTRAIT	LANDSCAPE	POSTER
UCS255N1A4	UCS255N2A4	210 X 297mm
UCS255N1A3	UCS255N2A3	297 X 420 mm
UCS255N1A2	UCS255N2A2	420 X 594 mm
UCS255N1A1	UCS255N2A1	594 X 841 mm
UCS255N1B2	UCS255N2B2	500 X 700 mm
UCS255N123	UCS255N223	508 X 762 mm



Single Sided

MATERIAL : Silver anodised aluminium

ARTICLE	POSTER
UCS245N1A4	210 X 297 mm
UCS245N1A3	297 X 420 mm
UCS245N1A2	420 X 594 mm
UCS245N1A1	594 X 841 mm
UCS245N1B2	500 X 700 mm
UCS245N123	508 X 762 mm

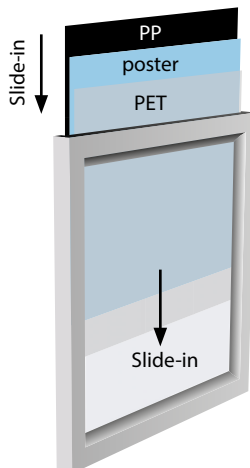

Color options :
Silver-anodized & Black



One set includes the upper and the bottom profiles with the end caps on both profiles and the hangers on the top profile. Improved rubber foam for poster suspension.

POSTER SNAP

MATERIAL : Silver anodised aluminium

ARTICLE	POSTER
UPT26SN021	210 mm
UPT26SN030	300 mm
UPT26SN042	420 mm
UPT26SN050	500 mm
UPT26SN060	600 mm
UPT26SN070	700 mm
UPT26SN085	850 mm
UPT26SN100	1000 mm

Patent TR 2005 01301



Suitable for heavier and bigger posters in thickness 50 micron - 500 micron. One set includes the end caps on both profiles and the hangers on the top profile.

POSTER CLAMP

MATERIAL : Silver anodised aluminium

ARTICLE	POSTER
UPCOOSN021	210 mm
UPCOOSN030	300 mm
UPCOOSN042	420 mm
UPCOOSN050	500 mm
UPCOOSN060	600 mm
UPCOOSN070	700 mm
UPCOOSN085	850 mm
UPCOOSN100	1000 mm



A lightweight frame that stretches the poster from 4 corners. The poster can be easily changed with the help of plastic clips. It is available in standard anodized silver. Other colors are available upon request. Two plastic hangers for both wall mounting and ceiling suspension are included. The plastic clips stretched from the corners place the poster in the center without spoiling or harming the poster paper.

STRETCH FRAME

A newly created series of poster clamps offers competitive solutions. Suitable for posters in thickness 50 micron / 500 micron. One set includes end caps on both profiles and hangers on the top profile.

NEWAGE POSTER CLAMP

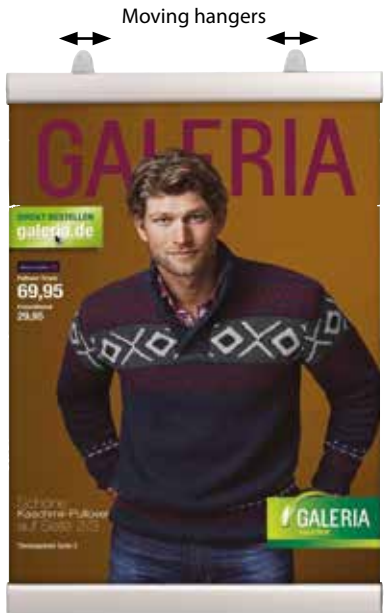

MATERIAL : Silver anodised aluminium

ARTICLE	POSTER
UPSCN000A4	210 X 297 mm
UPSCN000A3	297 X 420 mm
UPSCN000A2	420 X 594 mm
UPSCN000A1	594 X 841 mm
UPSCN000B2	500 X 700 mm
UPSCN000B1	700 X 1000 mm

MATERIAL : Silver anodised aluminium

ARTICLE	POSTER
UPC10SN021	210 mm
UPC10SN030	300 mm
UPC10SN042	420 mm
UPC10SN050	500 mm
UPC10SN060	600 mm
UPC10SN070	700 mm
UPC10SN085	850 mm
UPC10SN100	1000 mm
UPC10SN120	1200 mm





Suitable for heavier and bigger posters in thickness 10 micron - 500 micron. A double-sided poster holder. One set includes end caps on both profiles and hangers on the top profile. The product is supplied with 40 mm see/clear co-extrusion components inside which hold the poster.

POSTER FAST

MATERIAL : Silver anodised aluminium

ARTICLE	POSTER
UPF21SN021	210 mm
UPF21SN030	300 mm
UPF21SN042	420 mm
UPF21SN050	500 mm
UPF21SN060	600 mm
UPF21SN070	700 mm
UPF21SN085	850 mm
UPF21SN100	1000 mm
UPF21SN120	1200 mm



Double sided

Moving hangers

Double sided profile

21 mm



Please order panel separately



Please order panel separately



Wall fixing screws of Outdoor Flap Gripper are included in the pack which are CE certified multi-expansion long plugs. Special anti-corrosion coated screw is made of zinc coated steel and plastic sleeve made of high quality of nylon. It is confirmed for outdoor fixing on various exterior building surfaces such as concrete, solid or honeycomb brick, hollow dense or hollow light aggregate block, aerated concrete and solid stone.

Panel: 5 mm Plastech PVC Foam

ARTICLE	POSTER SIZE
UYOFG10610	620 X 1000 mm
UYOFG10612	620 X 1200 mm
UYOFG10615	620 X 1500 mm

MATERIAL : Silver anodised aluminium - excluding panel

ARTICLE	POSTER SIZE
UOFG00N100	620 X 1000 mm
UOFG00N120	620 X 1200 mm
UOFG00N150	620 X 1500 mm



OUTDOOR FLAP GRIPPER

Outdoor Flap Gripper offers innovative solutions for your advertising needs. It is designed to mount rigid panels onto outer walls using both sides of display poster. Then it gets the attention of 2-way traffic. It accepts rigid panels in 5mm thicknesses. EN certified wall fixing increase the security of the product in use. Fixing is covered by plastic end caps to provide clean finish to the product.



Suitable for use in open-air spaces or public areas such as schools, offices, hospitals, etc. 15 mm or 26 mm profile options are available. An anti-reflex PET cover protects your documents from tearing and suffering damage. Fixing availability with screws or adhesive tape both in landscape and portrait position.

DOOR SIGNS



15 mm



26 mm

PROFILE: 15 mm

ARTICLE	POSTER	ARTICLE	POSTER
UDS150NOA7	74 X 105 mm	UDS0001050	50 X 148 mm
UDS150NOA6	105 X 148 mm	UDS0002050	105 X 148 mm
UDS150NOA5	148 X 210 mm	UDS0003050	105 X 297 mm
UDS150NOA4	210 X 297 mm	UDS0004050	148 X 210 mm
UDS150NA43	99 X 210 mm	UDS0005050	210 X 297 mm

PROFILE: 26 mm

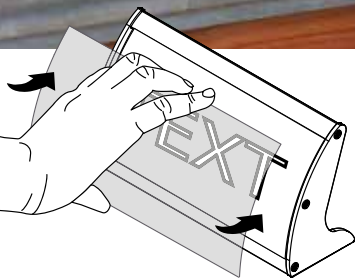

Offering a complete range, aluminium wall sign profiles are design to enable usage on a counter to match Wall Signs. Desktop Sign is fixed to a convenient reading angle to be seen by the customers easily. It is suitable for receptions, restaurants, cafés and many more. It is a practical product to change the message very often.

MATERIAL : Silver anodised aluminium

ARTICLE	POSTER SIZE
UMDS740N15	74 X 150 mm
UMDS740N20	74 X 200 mm
UMDS740N25	74 X 250 mm
UMDS105N15	105 X 150 mm
UMDS105N20	105 X 200 mm
UMDS105N25	105 X 250 mm
UMDS105N30	105 X 300 mm
UMDS148N20	148 X 200 mm
UMDS148N25	148 X 250 mm
UMDS148N30	148 X 300 mm



Suction Cup / UYAA006010

DESKTOP SIGN



Fast and Simple! Aluminium wall sign profiles are designed to create horizontally curved double sided suspended signs. Using your stock of single sided profiles, product offerings can be increased to double sided suspension style. Double Sided Wall Sign is suitable as directional signs, way finding. Suspension cables enclosed enables flexible positioning of the sign. Black endcaps complete the look.

DOUBLE SIDED WALL SIGN



Maximum recommended length: 500 mm

WALL SIGN DOUBLE SIDED: Silver anodised aluminium

	SINGLE LAYER	2- LAYER	3-LAYER	4- LAYER	5- LAYER
74 mm	✓	✓	✓	✓	✓
105 mm	✓	✓	✓	✓	✓
148 mm	✓	✓	✓	✓	✓

MATERIAL : Silver anodised aluminium

ARTICLE	DESCRIPTION
UYPDS00001	Double Sided Suspension Set / 2x4 m fishnet & 2xCeiling Hanger
UYPDS00002	Double Sided Fixing Set

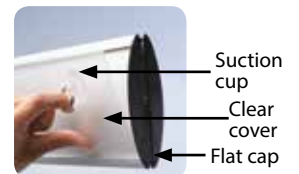

Fixing components (UYPDS00002) Suspension set (UYPDS00001)





Fast and simple!

The Wall Sign system is a perfect solution for wall posters and signs. It allows clear visibility for the poster and has an aesthetic curved shape. The stylish curved Wall Sign system in various sizes suits the room sign and way finding needs within the building. Designed for paper inserts and is offered in variety of profile types to match different projects. The front cover is anti-reflex which is flexed into place after inserting the paper. Poster inserts can be created from common inkjet or laser printers. Printed-paper inserts may be in portrait or landscape outline and various sizes fitting in 4 profile types.



148 x 300 mm



105 x 250 mm



74 x 150 mm



52 x 150 mm



Flat cap



Suction cap



Arc cap



Double sided tape



Poster
Clear cover

Arc cap

WALL SIGNS

WALL SIGN SYSTEM 52 mm

ARTICLE	Model	POSTER
UDS520NA10	Flat Endcap	52 X 100 mm
UDS520NA15	Flat Endcap	52 X 150 mm
UDS520NA20	Flat Endcap	52 X 200 mm
UDS520NA25	Flat Endcap	52 X 250 mm
UDS520NA30	Flat Endcap	52 X 300 mm
UDS520NA35	Flat Endcap	52 X 350 mm
UDS520NA40	Flat Endcap	52 X 400 mm
UDS520NA45	Flat Endcap	52 X 450 mm
UDS520NB10	Arc Endcap	52 X 100 mm
UDS520NB15	Arc Endcap	52 X 150 mm
UDS520NB20	Arc Endcap	52 X 200 mm
UDS520NB25	Arc Endcap	52 X 250 mm
UDS520NB30	Arc Endcap	52 X 300 mm
UDS520NB35	Arc Endcap	52 X 350 mm
UDS520NB40	Arc Endcap	52 X 400 mm
UDS520NB45	Arc Endcap	52 X 450 mm

WALL SIGN SYSTEM 74 mm

ARTICLE	Model	POSTER
UDS740NA15	Flat Endcap	74 X 150 mm
UDS740NA20	Flat Endcap	74 X 200 mm
UDS740NA25	Flat Endcap	74 X 250 mm
UDS740NA30	Flat Endcap	74 X 300 mm
UDS740NA35	Flat Endcap	74 X 350 mm
UDS740NA40	Flat Endcap	74 X 350 mm
UDS740NA45	Flat Endcap	74 X 450 mm
UDS740NA50	Flat Endcap	74 X 500 mm
UDS740NB15	Arc Endcap	74 X 150 mm
UDS740NB20	Arc Endcap	74 X 200 mm
UDS740NB25	Arc Endcap	74 X 250 mm
UDS740NB30	Arc Endcap	74 X 300 mm
UDS740NB35	Arc Endcap	74 X 350 mm
UDS740NB40	Arc Endcap	74 X 350 mm
UDS740NB45	Arc Endcap	74 X 450 mm
UDS740NB50	Arc Endcap	74 X 500 mm

WALL SIGN SYSTEM 105 mm

ARTICLE	Model	POSTER
UDS105NA25	Flat Endcap	105 X 250 mm
UDS105NA30	Flat Endcap	105 X 300 mm
UDS105NA35	Flat Endcap	105 X 350 mm
UDS105NA40	Flat Endcap	105 X 400 mm
UDS105NA50	Flat Endcap	105 X 500 mm
UDS105NA60	Flat Endcap	105 X 600 mm
UDS105NB25	Arc Endcap	105 X 250 mm
UDS105NB30	Arc Endcap	105 X 300 mm
UDS105NB35	Arc Endcap	105 X 350 mm
UDS105NB40	Arc Endcap	105 X 400 mm
UDS105NB50	Arc Endcap	105 X 500 mm
UDS105NB60	Arc Endcap	105 X 600 mm

WALL SIGN SYSTEM 148 mm

ARTICLE	Model	POSTER
UDS148NA30	Flat Endcap	148 X 300 mm
UDS148NA35	Flat Endcap	148 X 350 mm
UDS148NA40	Flat Endcap	148 X 400 mm
UDS148NA50	Flat Endcap	148 X 500 mm
UDS148NA60	Flat Endcap	148 X 600 mm
UDS148NA65	Flat Endcap	148 X 650 mm
UDS148NB30	Arc Endcap	148 X 300 mm
UDS148NB35	Arc Endcap	148 X 350 mm
UDS148NB40	Arc Endcap	148 X 400 mm
UDS148NB50	Arc Endcap	148 X 500 mm
UDS148NB60	Arc Endcap	148 X 600 mm
UDS148NB65	Arc Endcap	148 X 650 mm



TDFJ92W002
Chromed Toilet Signs, Women



TDFJ92X002
Chromed Toilet Signs, Men



Back Side



Chrome coated 3D toilet signs are available for men and women in 92 mm and clean neat finish add value to the signs. Easy to apply on the door or wall with self-adhesive tape provided on the back of each sign.

TOILET LOGO SYSTEMS

MATERIAL: Chrome

ARTICLE	HEIGHT	DESCRIPTION
TDFJ92X002	92 mm	Silver- Men
TDFJ92W002	92 mm	Silver - Women



Chrome coated plastic House Numbers offered in a pack 0-9. Easy to apply on various surfaces with self-adhesive tape on the back of each sign.

HOUSE NUMBER

MATERIAL: Chrome coated plastic

ARTICLE	HEIGHT	DESCRIPTION
TDFH700002	70 mm	Silver - 0-9





Oval shape plastic injected toilet signs has both colour and size options: Gold, Silver and Bronze & 120mm and 150mm heights. Braided frame and leather-textured backing completes elegant look.

DECORATIVE TOILET SIGN



Silver Frame, Dark Grey Panel, Men



Silver Frame, Dark Grey Panel, Women



Gold Frame, Dark Grey Panel, Men



Gold Frame, Dark Grey Panel, Women

MATERIAL: Plastic injected

ARTICLE	EXTERNAL (x-y)	DESCRIPTION
TDFY28LF03	88 X 120 mm	Gold - Men
TDFY28WF03	88 X 120 mm	Gold - Women
TDFY29LF02	110 X 150 mm	Silver - Men
TDFY29WF02	110 X 150 mm	Silver - Women
TDFY31LF04	110 X 150 mm	Bronze - Men
TDFY31WF04	110 X 150 mm	Bronze - Women



Bronze Frame, Dark Grey Panel, Men



Bronze Frame, Dark Grey Panel, Women

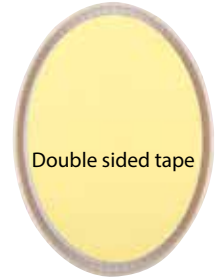

Back



150 x150 mm-Female, Silver Plastic Frame Aluminium Panel With Braille



150 x150 mm-Men, Silver Plastic Frame Aluminium Panel With Braille

MATERIAL: Aluminium

ARTICLE	EXTERNAL (x-y)	DESCRIPTION
TDFL050002	150 X 150 mm	Silver- Men
TDFL060002	150 X 150 mm	Silver - Women



150x150 mm aluminium Braille Toilet Signs are plastic framed. The signs are in corporated a combination of tactile text and printed text. It is available in Men and Women options. Easy to apply with double sided tape provided on the back of each sign.

6X6 BARILLE SIGN



Chrome framed Braille Signs are made of plastics. The signs incorporated a combination of tactile text and printed text. It has Men, Women, No Smoking and Exit options. Easy to apply with self-adhesive tape provided on the back of each sign.

ABS PLASTIC BARILLE SIGN

MATERIAL: Plastic

ARTICLE	EXTERNAL (x-y)	DESCRIPTION
TDFY010002	150 X 200 mm	Silver - Men
TDFY020002	150 X 200 mm	Silver - Women
TDFY090002	150 X 200 mm	Silver - No Smoking
TDFY100002	150 X 200 mm	Silver - Exit



WOMEN, Braille signs. With double-side tape on the back.



MEN, Braille signs. With double-side tape on the back.



EXIT, braille signs. With double-side tape on the back.



NO SMOKING, braille signs. With double-side tape on the back.





150x200 mm brushed Aluminium Braille Toilet Signs are plastic framed. The signs incorporated a combination of tactile text and printed text. It is available in Men and Women options. Easy to apply with self-adhesive tape provided on the back of each sign.

6X8 BARILLE SIGN

MATERIAL: Aluminium

ARTICLE	EXTERNAL (x-y)	DESCRIPTION
TDFL070002	150 X 200 mm	Silver- Men
TDFL080002	150 X 200 mm	Silver - Women



150x200 mm-Men / Female, Silver Plastic Frame Aluminum Panel With Braille



127x127 mm -No Smoking, Silver Plastic Frame Aluminum Panel With Braille



MATERIAL: Aluminium

ARTICLE	EXTERNAL (x-y)	DESCRIPTION
TDFL110002	127 X 127 mm	Silver



127x127mm brushed aluminium Braille NO SMOKING Signs are plastic framed. Easy to apply with self-adhesive tape provided on the back of each sign.

5X5 BARILLE SIGN



Designed as frameless, Standoff Mount Acrylic Sign is a practical display system allowing to change poster when it is still on the wall by sliding. It is suitable for environments where the advertisement or promotions are changed very often such as offices, meeting rooms, travel agents, hotels, restaurants and many more. Standoff Mount Acrylic Sign is also suitable for branding.

MATERIAL : Clear acrylic 2 mm

ARTICLE	POSTER SIZE
USMS000A4	297 X 420 mm
USMS000A3	210 X 297 mm
USMS000A2	420 X 594 mm

STANDOFF MOUNT ACRYLIC SIGN



MATERIAL : Silver anodised aluminium

ARTICLE	SIZE	DESCRIPTION
UMIFUN1007	1000 X 700 mm	USA Geographical
UMIFAN1007	1000 X 700 mm	Europe Geographical
UMIFDN1007	1000 X 700 mm	World Geographical
UMISUN1007	1000 X 700 mm	USA Political
UMISAN1007	1000 X 700 mm	Europe Political
UMISDN1007	1000 X 700 mm	World Political
UMIFUN1210	1200 X 1000 mm	USA Geographical
UMIFAN1210	1200 X 1000 mm	Europe Geographical
UMIFDN1210	1200 X 1000 mm	World Geographical
UMISUN1210	1200 X 1000 mm	USA Political
UMISAN1210	1200 X 1000 mm	Europe Political
UMISDN1210	1200 X 1000 mm	World Political



UYTFB00000 Acrylic magnetic tray for board marker.

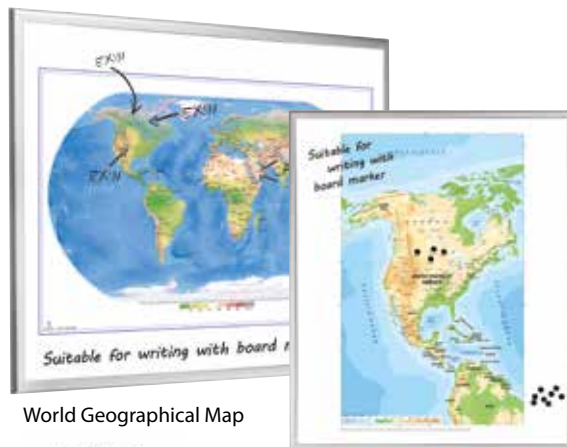

World Geographical Map

USA Geographical Map



Magnetic buttons UYUP397000



Highly durable full colour whiteboard magnetic maps.

These detailed and informative maps are framed and encapsulated in a drywipe surface with a magnetic backing board; enabling them to be drawn on or used with magnetic or self adhesive accessories. These multi-functional maps are ideal for sales area planning, campaign management, delivery planning, postal planning, and graphical distributor/ supplier identification. We offer the most popular map types to suit your application; political and geographical. Mounted and framed maps with dry-wipe surface.

MAP BOARD



Heavy duty, textured steel Clip Board is designed for the most demanding environments such as healthcare, offices, catering and any outdoor work. Stain free surface allows easy cleaning of the product. It is complete with silver anodised, strong and high capacity snap-open clip. Round corners allows using in busy work areas.

CLIP BOARD

MATERIAL : Steel powder coated

ARTICLE	DESCRIPTION	CAPACITY
UCIB000A4	Clip Board	A4
UCIBD002A4	Clip Board Wall Unit	2 X A4
UCIBD003A4	Clip Board Wall Unit	3 X A4
UCIBD004A4	Clip Board Wall Unit	4 X A4

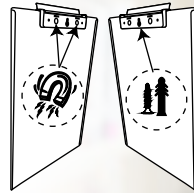
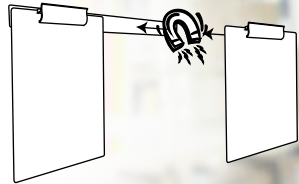

2XA4 Clip Board
Steel bar length 460x35 mm

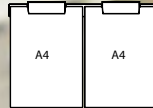

3XA4 Clip Board
Steel bar length 700x35 mm

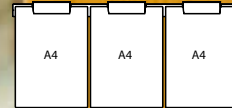

4XA4 Clip Board
Steel bar length 940x35 mm

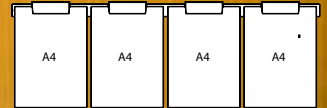

peel & stick



MATERIAL : Silver anodised aluminium

ARTICLE	EXTERNAL (x)	POSTER
UFN000N031	335 mm	310 mm
UFN000N050	525 mm	500 mm
UFN000N058	605 mm	580 mm
UFN000N088	905 mm	880 mm
UFN000N100	1025 mm	1000 mm
UFN000N118	1205 mm	1180 mm
UFN000N150	1525 mm	1500 mm

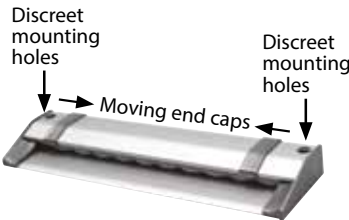

Fast Note is a product which enables you to hang your papers, notes, pictures or photos without magnets or pins. It has a slim and compact design. Thanks to the cylinders in the profile you can easily keep the paper inside. Fast Note is suitable for restaurants, agencies, studios, hospitals, hotels, conference rooms, houses and offices.

FAST NOTE



Double sided magnetic drywipe and revolving Whiteboard which offers one side plain smooth surface and the other side allows inserting papers together with drywipe surface. Sturdy Aluminium framed Whiteboards available in large sizes for presentations, training rooms, hanging artworks, maps and charts. The Fast Note on the other side allows inserting various sheets of paper and it is held in place with specially designed rollers. Easy to move the board with locking wheels.

WHITE BOARD

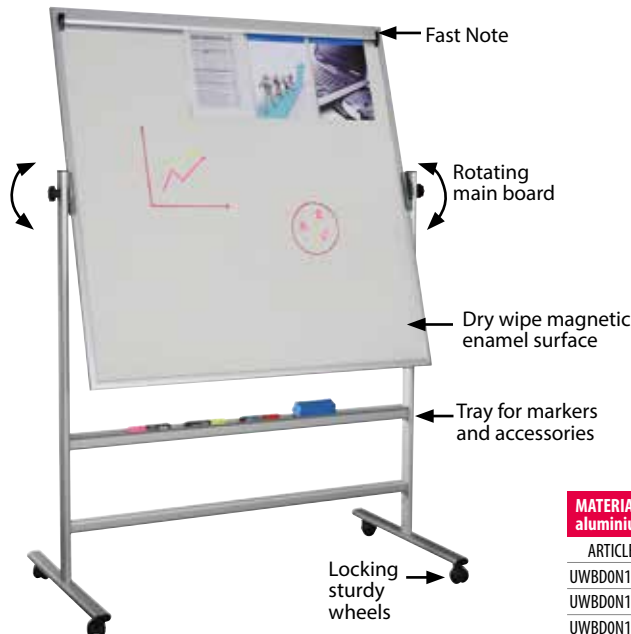

Magnetic PET Pocket
Please don't forget to order

MATERIAL : Silver anodised aluminium

ARTICLE	EXTERNAL (x)
UWBDON1290	900 mm
UWBDON1212	1200 mm
UWBDON1215	1500 mm

PET POCKET: Magnetic

ARTICLE	DESCRIPTION
UPCMOR00A4	Magnetic A4 Red
UPCMOB00A4	Magnetic A4 Black
UPCMOW00A4	Magnetic A4 White
UPCMOG00A4	Magnetic A4 Gray
UPCMOG00A5	Magnetic A5 Gray
UPCMOB00A5	Magnetic A5 Black



Variety of Tabletop Reference Racks are available for different use and taste. If heavy is required, Steel reference racks is recommended. If looking for lighter, there are options for rotating, round base or Adjustable. Each is great use for tiding busy environment.

REFERENCE RACKS



Adjustable

MATERIAL : Plastic		
ARTICLE	PAPER SIZE	DESCRIPTION
TAB5899002	210 X 297 mm	White

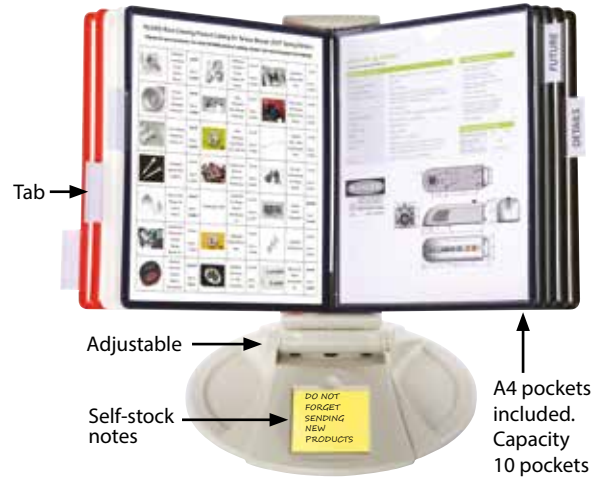

Adjustable with Round Base

MATERIAL : Plastic		
ARTICLE	PAPER SIZE	DESCRIPTION
TAB5868002	210 X 297 mm	White

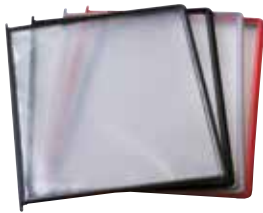

Please don't forget to order. 10 pcs of 1 colour in a box.

POSTER POCKET

ARTICLE	PAPER SIZE	DESCRIPTION
TAB0590304	210 X 297 mm	Red
TAB0590301	210 X 297 mm	Black
TAB0590309	210 X 297 mm	Grey
TAB5904003	Tab & Inset	Clear

Tab & Inset. Please don't forget to order.

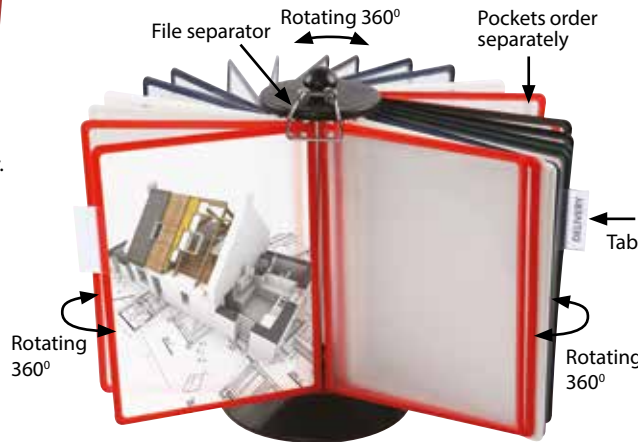

360° Rotating

MATERIAL : Plastic		
ARTICLE	PAPER SIZE	DESCRIPTION
TAB5897001	210 X 297 mm	Black



Steel Table Top

MATERIAL : Steel		
ARTICLE	PAPER SIZE	DESCRIPTION
URK01N00A4	210 X 297 mm	Silver
URK01B00A4	210 X 297 mm	Black

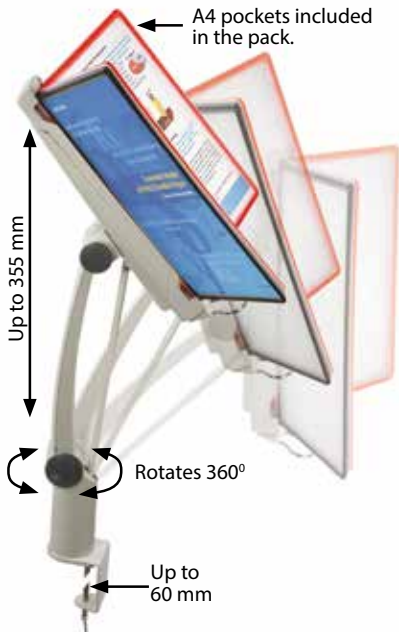

Flexible

MATERIAL : Plastic		
ARTICLE	PAPER SIZE	DESCRIPTION
TAB5845002	210 X 297 mm	White



Wall Mount Plastic

MATERIAL : Plastic		
ARTICLE	PAPER SIZE	DESCRIPTION
TAB5935002	210 X 297 mm	White



Wall Mount Steel

MATERIAL : Silver anodised aluminium		
ARTICLE	PAPER SIZE	DESCRIPTION
URK03N00A4	210 X 297 mm	Silver
URK03B00A4	210 X 297 mm	Black



Free Standing

MATERIAL : Silver anodised aluminium

ARTICLE	PAPER SIZE	DESCRIPTION
URK04N00A4	210 X 297 mm	Silver
URK04B00A4	210 X 297 mm	Black

Made of beechwood. Both accommodates varying canvas Sizes. Adjustable back support ensures stability and comfortable use at different angles. It folds flat for easy storage.

EASELS

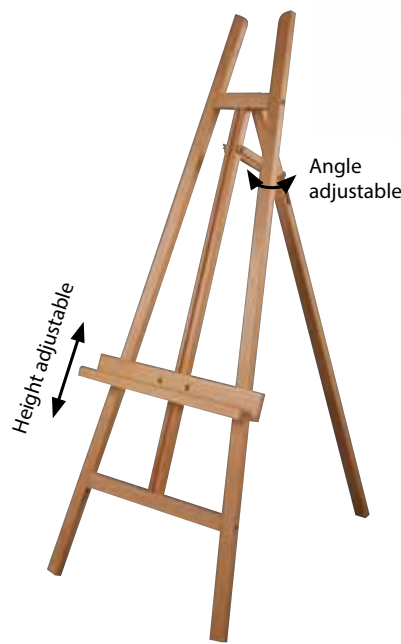

Modern

MATERIAL: Beech Wood

ARTICLE	SIZE
USLM000015	600 X 790 X 1480 mm



Art

MATERIAL: Beech Wood

ARTICLE	SIZE
USLA000012	600 X 550 X 1530 mm

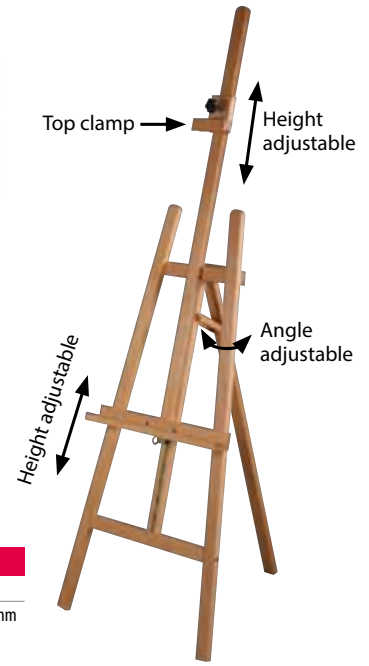

Floor Standing

MATERIAL : Silver anodised aluminium

ARTICLE	PAPER SIZE	DESCRIPTION
URK05N00A4	210 X 297 mm	Silver
URK05B00A4	210 X 297 mm	Black

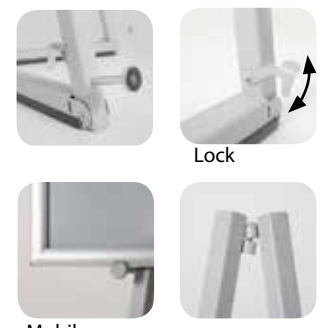
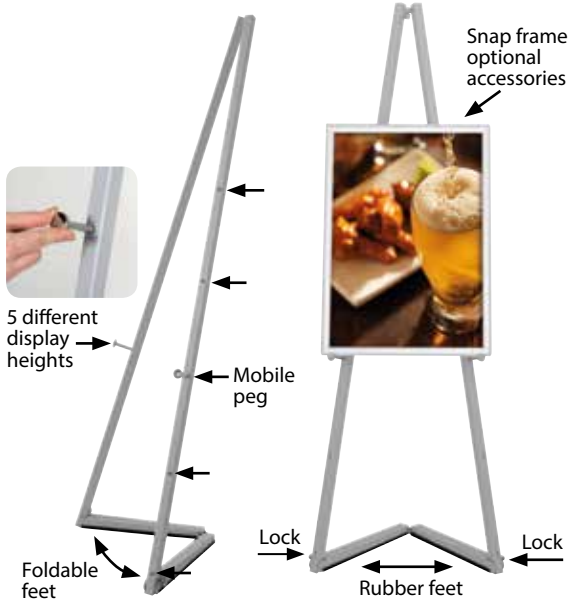

Color options : Silver-anodized & Black

Portable

MATERIAL: Steel

ARTICLE	SIZE	DESCRIPTION
UPESLOG015	1500 X 536 X 309 mm	Gray
UPESLOB015	1500 X 536 X 309 mm	Black



You will find flip charts to suit every purpose here. Ideal for business use, these flip charts are durable and highly practical with or without wheels or adjustable height. There are options for hotels and conference facilities, offices or even educational purposes. Each flip chart accommodates magnetic and drywipe surface, paper clamp and pen tray. You can chose the best for your need!

FLIP CHARTS

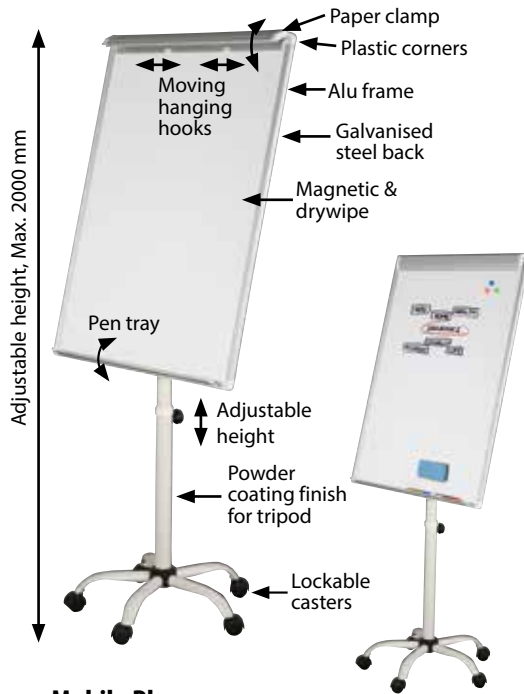

Mobile Plus

MATERIAL: Steel & aluminium

ARTICLE	BOARD SIZE	WRITABLE AREA	COLOUR
TWYFC55501	700 X 1000 mm	655 X 915 mm	White

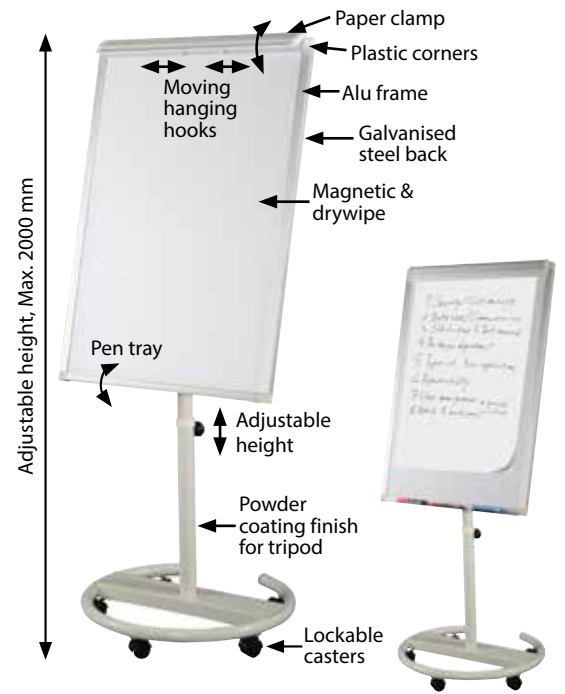

Professional Mobile

MATERIAL: Steel & aluminium

ARTICLE	BOARD SIZE	WRITABLE AREA	COLOUR
TWYFC88801	700 X 1000 mm	655 X 915 mm	White

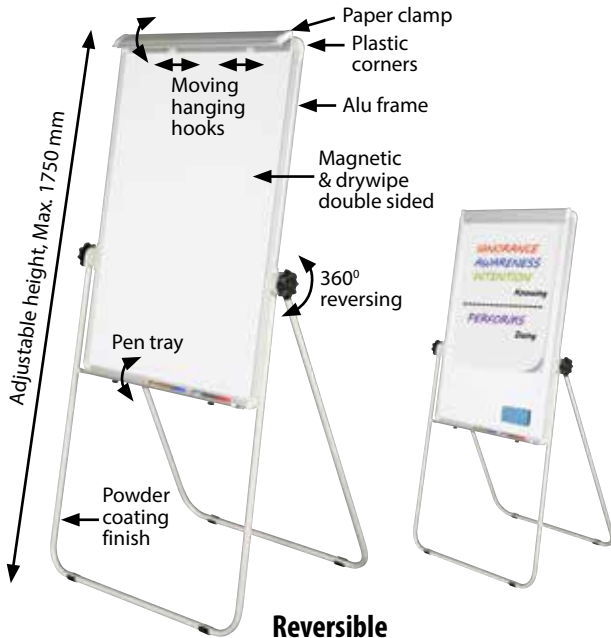

Reversible

MATERIAL: Steel & aluminium

ARTICLE	BOARD SIZE	WRITABLE AREA	COLOUR
TWYFC66601	700 X 1000 mm	640 X 905 mm	White

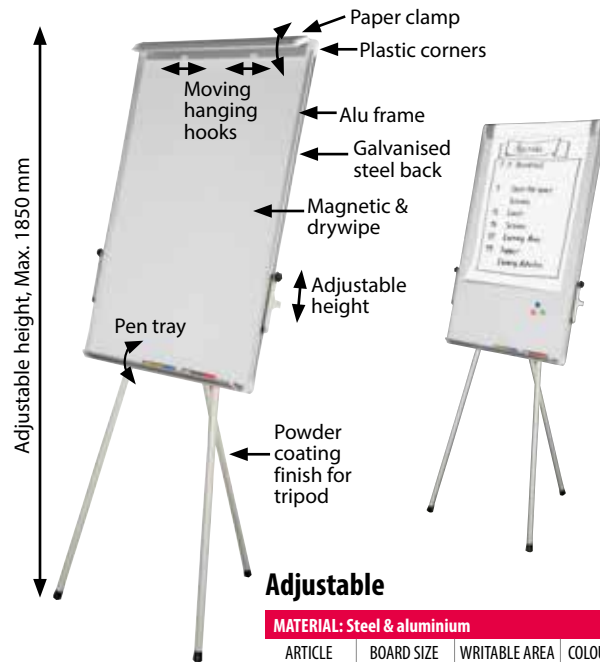

Adjustable

MATERIAL: Steel & aluminium

ARTICLE	BOARD SIZE	WRITABLE AREA	COLOUR
TWYFC33301	600 X 900 mm	540 X 805 mm	White



Magnetic buttons included.



Magnetic Eraser included.

	Adjustable	Reversible	Mobile Plus	Professional Mobile
Surface	Single side, magnetic surface	Single side, magnetic surface	Single side, magnetic surface	Single side, magnetic surface
Board Размер (WxH)	600 x 900 mm	700 x 1000 mm	700 x 1000 mm	700 x 1000 mm
Height Adjustment	Max. 1850 mm	Max. 1750 mm	Max. 2000 mm	Max. 2000 mm
Stand/Pedestal	Metal, Tripod	Metal, Tetrapod	Mobile with 5 wheels	Mobile with 5 wheels
Blockholder, Marker Holder	Paper clamp, hanging hooks and tray	Paper clamp, hanging hooks and tray	Paper clamp, hanging hooks and tray	Paper clamp, hanging hooks and tray
Eraser, Markers	A magnetic eraser & 3 magnets are supplied	A magnetic eraser & 3 magnets are supplied	A magnetic eraser & 3 magnets are supplied	A magnetic eraser & 3 magnets are supplied
Material	Core: Cardboard+MDF, Alu frame + Plastic corners	Core: Cardboard+MDF, Alu frame + Plastic corners	Core: Cardboard+MDF, Alu frame + Plastic corners	Core: Cardboard+MDF, Alu frame + Plastic corners



We offer various menuboards for your different use and purpose. A range of free standing menuboards and information poster stands are available as illuminated or non-illuminated. These are designed for restaurants, banks, hotel marketing or even for directional signs.

MENUBOARDS



Landscape & Portrait lock

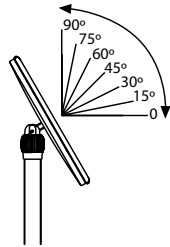

One product, two positions (landscape & portrait)



Patent Pending TR 2007 06354 - TR 2007 03453 - PCT/TR 2007/000131 - DE 20 2007 016 574 - OHIM 000748223-0001,2 - FR 760305 - US 29/295.750 - US D 597, 764 S - JP 2007-022472 - JP 2007-022473 - CN 200730321542.4 - CN 200730321543.

Flexible

MATERIAL : Silver anodised aluminium

ARTICLE	H max.	H min.	POSTER	DESCRIPTION
UDMB6005A4	1205 mm	865 mm	297 X 210 mm	Landscape
	1250 mm	910 mm	210 X 297 mm	Portrait
UDMB6005A3	1250 mm	910 mm	420 X 297 mm	Landscape
	1310 mm	970 mm	297 X 420 mm	Portrait

Flexible with Fixed Height

MATERIAL : Silver anodised aluminium

ARTICLE	Height	POSTER	DESCRIPTION
UDMB7005A4	967 mm	297 X 210 mm	Landscape
	1010 mm	210 X 297 mm	Portrait
UDMB7005A3	1014 mm	420 X 297 mm	Landscape
	1076 mm	297 X 420 mm	Portrait



One product, two positions (landscape & portrait)

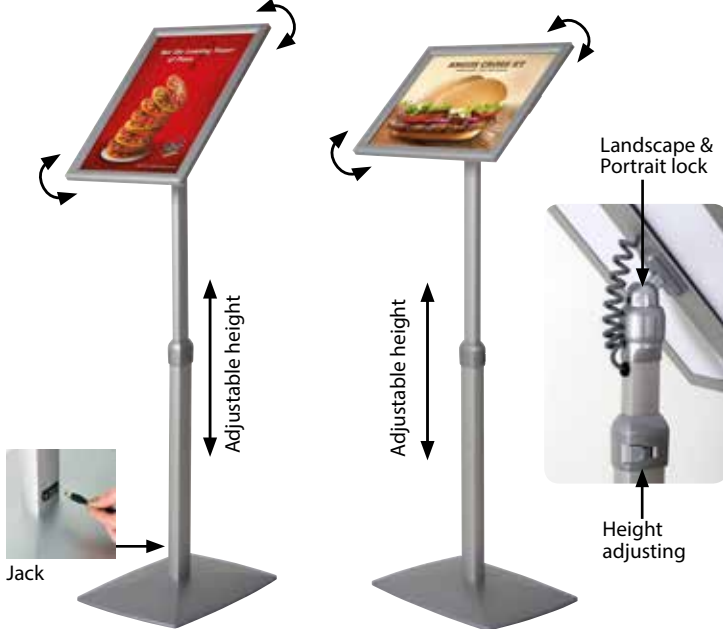

Jack

Height adjusting

Flexible with Ledbox

MATERIAL : Silver anodised aluminium

ARTICLE	H max.	H min.	POSTER	DESCRIPTION	LIGHTING
UFML00N0A4	1205 mm	865 mm	297 X 210 mm	Silver Landscape	3000-3300 W
	1250 mm	910 mm	210 X 297 mm	Silver Portrait	3000-3300 W
UFML00N0A3	1250 mm	910 mm	420 X 297 mm	Silver Landscape	2800-3000 W
	1310 mm	910 mm	297 X 420 mm	Silver Portrait	2800-3000 W
UFML10B0A4	fixed height	fixed height	297 X 210 mm	Black Landscape	3000-3300 W
	fixed height	fixed height	210 X 297 mm	Black Portrait	3000-3300 W
UFML10B0A3	fixed height	fixed height	420 X 297 mm	Black Landscape	2800-3000 W
	fixed height	fixed height	297 X 420 mm	Black Portrait	2800-3000 W

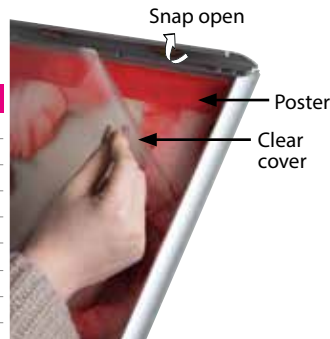

Optional accessories

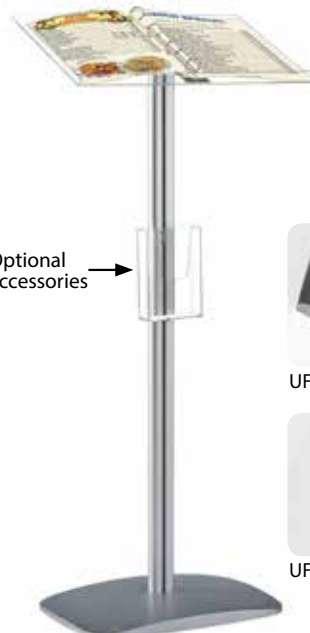

UFSL003300

UFSL002100

UFSL003100

UFSL002200

UFSL003200

MATERIAL: Acrylic

SHELF	DESCRIPTION	CAPACITY
UFSL002100	Steel shelf	2 X A5
UFSL003100	Acrylic shelf	2 X A5
UFSL002200	Steel shelf	1 X A4
UFSL003200	Acrylic shelf	1 X A4
UFSL003300	Acrylic shelf	1 X A4

Folder

MATERIAL : Silver anodised aluminium

ARTICLE	CAPACITY
UDMB2002A4	2 X A4

Some possible Variations

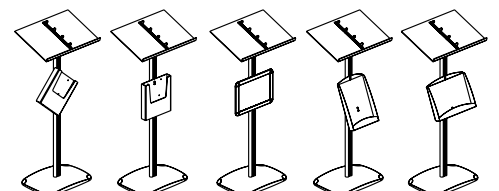

Classical

MATERIAL : Silver anodised aluminium

MITRED ARTICLE	ROUND ARTICLE	HEIGHT	POSTER	DESCRIPTION
UCMB1N05A4	UCMB1N00A4	1000 mm	297 X 210 mm	A4 Portrait
		964 mm	210 X 297 mm	A4 Landscape
UCMB1N05A3	UCMB1N00A3	1200 mm	420 X 297 mm	A3 Portrait
		1150 mm	297 X 420 mm	A3 Landscape



**One product,
two positions
(landscape&portrait)**



Decorative

MATERIAL : Silver anodised aluminium

MITRED ARTICLE	ROUND ARTICLE	HEIGHT	POSTER	DESCRIPTION
UDMB1N05A4	UDMB1N00A4	1000 mm	297 X 210 mm	A4 Portrait
		964 mm	210 X 297 mm	A4 Landscape
UDMB1N05A3	UDMB1N00A3	1200 mm	420 X 297 mm	A3 Portrait
		1150 mm	297 X 420 mm	A3 Landscape



**One product,
two positions
(landscape&portrait)**



Curved

MATERIAL : Silver anodised aluminium & Black aluminium

SILVER MITRED	SILVER ROUND	BLACK MITRED	POSTER	HEIGHT	DESCRIPTION
UCUMBNO5A4	UCUMBNO0A4	UCUMBB05A4	210 X 297 mm	1212 mm	A4 Portrait
				1176 mm	A4 Landscape
UCUMBNO5A3	UCUMBNO0A3	UCUMBB05A3	297 X 420 mm	1262 mm	A3 Portrait
				1212 mm	A3 Landscape



**One product,
two positions
(landscape&portrait)**

Curved with Acryled

MATERIAL : Silver anodised aluminium & Black aluminium

SILVER	BLACK	HEIGHT	POSTER	DESCRIPTION
UCUALN00A4	UCUALB00A4	1250 mm	297 X 210 mm	A4 Portrait
		1215 mm	210 X 297 mm	A4 Landscape
UCUALN00A3	UCUALB00A3	1250 mm	420 X 297 mm	A3 Portrait
		1303 mm	297 X 420 mm	A3 Landscape





SHELF		
ARTICLE	CAPACITY	DESCRIPTION
UFSL002100	2 X A5	Steel shelf
UFSL003100	2 X A5	Acrylic shelf
UFSL002200	1 X A4	Steel shelf
UFSL003200	1 X A4	Acrylic shelf
UFSL003300	1 X A4	Acrylic shelf



Some possible variations

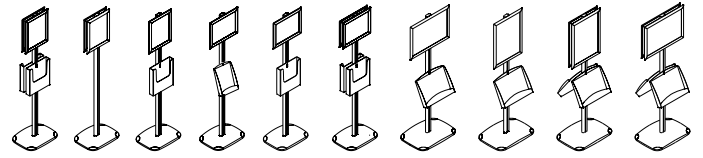

Adjustable

MATERIAL : Silver anodised aluminium		
MITRED ARTICLE	ROUND ARTICLE	POSTER
UDMB1005A4	UDMB1000A4	210 X 297 mm
UDMB1005A3	UDMB1000A3	297 X 420 mm

MATERIAL : Black & Black hammered powder coated

ARTICLE	CAPACITY	DESCRIPTION	HEIGHT
UMB00B04A4	4 X A4	Black	1270 mm / Portrait
UMB00N04A4	4 X A4	Hammered Black	1205 mm / Landscape

MATERIAL : Black & Black hammered powder coated

ARTICLE	CAPACITY	DESCRIPTION
UMB00B03A4	3 X A4	Black
UMB00N03A4	3 X A4	Hammered Black



Color options :
Black & hammered black.



Magnetic buttons
UYUP397000



Produced with durable steel material to suit outdoor conditions, Restaurant board is ideal for displaying menus, special offers, events and more. Steel base is covered with soft material to protect the floors. Textured black or Black-Grey finish is available. Message can be changed easily and captures the customer's attention in all frequented traffic areas.

RESTAURANT BOARDS

Our new stylish Curved free standing message board captures the customer's attention in all frequented traffic areas.

UNIVERSAL SHOWBOARD ON CURVED POST



MATERIAL : Black aluminium

ARTICLE	CAPACITY	DESCRIPTION
UCUS2B0481	4 X A4	Cork
UCUS3B0481	4 X A4	Magnetic



The aluminium A Boards are durable and stable pavement signs, that holds printed poster, menus and deals and helps to get noticed in various environments. This outdoor sign has an easy to use snap open, front loading profiles which allows for a quick change of the poster. We offer different profiles with different corner finishings; Mitred, round and safe. It is ready for use as requires no tool assembly.

A BOARDS

Profile Type

25 mm

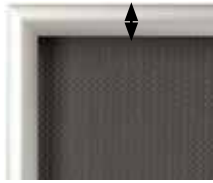

30 mm

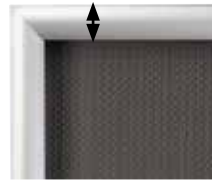

32 mm

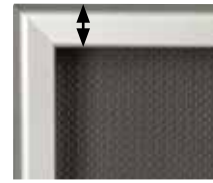

35 mm

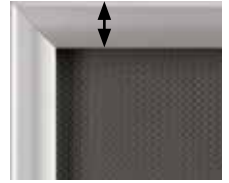

Corner Types



Mitred corner



Round corner



Safe corner

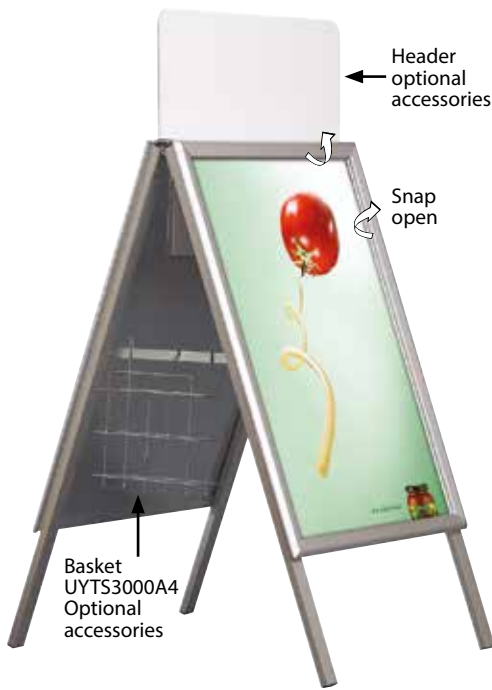

HEADER: 4 mm Plastech PVC Foam

ARTICLE	F1	F2
UYFT0000A2	460 mm	382 mm
UYFT0000A1	640 mm	562 mm
UYFT0000A1	640 mm	562 mm
UYFT0000A0	890 mm	812 mm
UYFT0000B2	540 mm	462 mm
UYFT0000B1	740 mm	662 mm
UYFT000023	548 mm	470 mm
UYFT000034	802 mm	724 mm

HEADER HOLDER

ARTICLE	X
UYTT0000A2	405 mm
UYTT0000A1	579 mm
UYTT0000A1	579 mm
UYTT0000A0	826 mm
UYTT0000B2	485 mm
UYTT0000B1	685 mm
UYTT000023	493 mm
UYTT000034	747 mm

Header

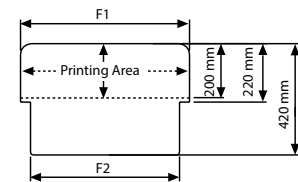

Header Holder

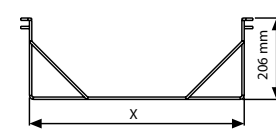

A Board

MATERIAL : Silver anodised aluminium PROFILE : 32 mm profile

MITRED ARTICLE	ROUND ARTICLE	SAFE CORNER	POSTER
UAB3250NA2	UAB3200NA2	UAB3210NA2	420 X 594 mm
UAB3250NA1	UAB3200NA1	UAB3210NA1	594 X 841 mm
UAB3251NA1	UAB3201NA1	UAB3211NA1	594 X 841 mm
UAB3250NA0	UAB3200NA0	UAB3210NA0	841 X 1189 mm
UAB3250NB2	UAB3200NB2	UAB3210NB2	500 X 700 mm
UAB3250NB1	UAB3200NB1	UAB3210NB1	700 X 1000 mm
UAB3250N23	UAB3200N23	UAB3210N23	508 X 762 mm
UAB3250N34	UAB3200N34	UAB3210N34	762 X 1016 mm



Eco A Board

MATERIAL : Silver anodised aluminium

32 mm MITRED	32 mm ROUND	SAFE CORNER	25 mm MITRED	25 mm ROUND	POSTER
UAB325HNA1	UAB320HNA1	UAB321HNA1	UAB255HNA1	UAB250HNA1	594 X 841 mm
UAB325HNB2	UAB320HNB2	UAB321HNB2	UAB255HNB2	UAB250HNB2	500 X 700 mm
UAB325HNB1	UAB320HNB1	UAB321HNB1	UAB255HNB1	UAB250HNB1	700 X 1000 mm



Also see with safe corner

Weatherproof

MATERIAL : Silver anodised aluminium

ARTICLE	POSTER
UAB3550NA2	420 X 594 mm
UAB3550NA1	594 X 841 mm
UAB3550NB2	500 X 700 mm
UAB3550NB1	700 X 1000 mm

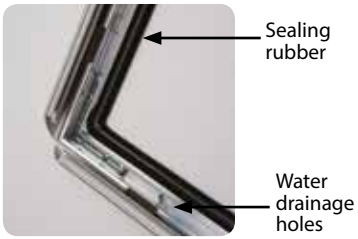

Sealing rubber

Water drainage holes



Snap open

Anodised leg

Opti Frame

MATERIAL : Silver anodised aluminium

32 mm MITRED	32 mm ROUND	25mm MITRED	25 mm ROUND	POSTER
UOAB325NA1	UOAB320NA1	UOAB255NA1	UOAB250NA1	594 X 841 mm
-	-	UOAB255NA2	UOAB250NA2	420 X 594 mm
UOAB325NB2	UOAB320NB2	UOAB255NB2	UOAB250NB2	500 X 700 mm

Opti®
Frame
A Board



Snap open

Safe corner

25 mm Opti frame

PS backing

Mill finish legs

Write On

MATERIAL : Silver anodised aluminium

ARTICLE	POSTER	DESCRIPTION
UWABONWOF1	600 X 800 mm	Silver-White
UWABONBOF1	600 X 800 mm	Silver-Black
UWABOBWOF1	600 X 800 mm	Black-White
UWABOBBOF1	600 X 800 mm	Black-Black



Legs Silver-Black surface



Legs Black-white surface



Legs Black-Black surface



Legs Silver-white surface

Wood Look

MATERIAL : Aluminium

ARTICLE	COPY AREA	DESCRIPTION
UAWL000F1	600 X 800 mm	without header
UAWL1000F1	600 X 800 mm	with decorative header



Decorative header is an optional accessory



Customized header.

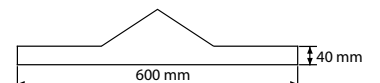
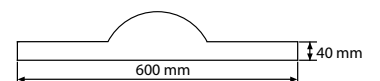
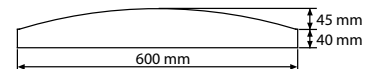

Don't forget to order
Chalkboard Marker
UYAKLM1251 - Colour Marker
UYAKLM1250 - White Marker



Writing area
is suitable for
chalkboard marker

Premium with Logo

MATERIAL : Silver anodised aluminium		
ARTICLE	POSTER	HEDAER PRINTING
UAPO305NA0	841 X 1189 mm	884 X 150 mm
UAPO305NA1	594 X 841 mm	637 X 150 mm
UAPO305NA2	420 X 594 mm	463 X 150 mm
UAPO305NB1	700 X 1000 mm	743 X 150 mm
UAPO305NB2	500 X 700 mm	543 X 150 mm
UAPO305N23	508 X 762 mm	551 X 150 mm
UAPO305N34	762 X 1016 mm	805 X 150 mm



Premium with Profile Logo

MATERIAL : Silver anodised aluminium		
ARTICLE	POSTER	HEADER PRINTING
UAP1305NA0	841 X 1189 mm	841 X 120 mm
UAP1305NA1	594 X 841 mm	594 X 120 mm
UAP1305NA2	420 X 594 mm	420 X 120 mm
UAP1305NB1	700 X 1000 mm	700 X 120 mm
UAP1305NB2	500 X 700 mm	500 X 120 mm
UAP1305N23	508 X 762 mm	508 X 120 mm
UAP1305N34	762 X 1016 mm	762 X 120 mm

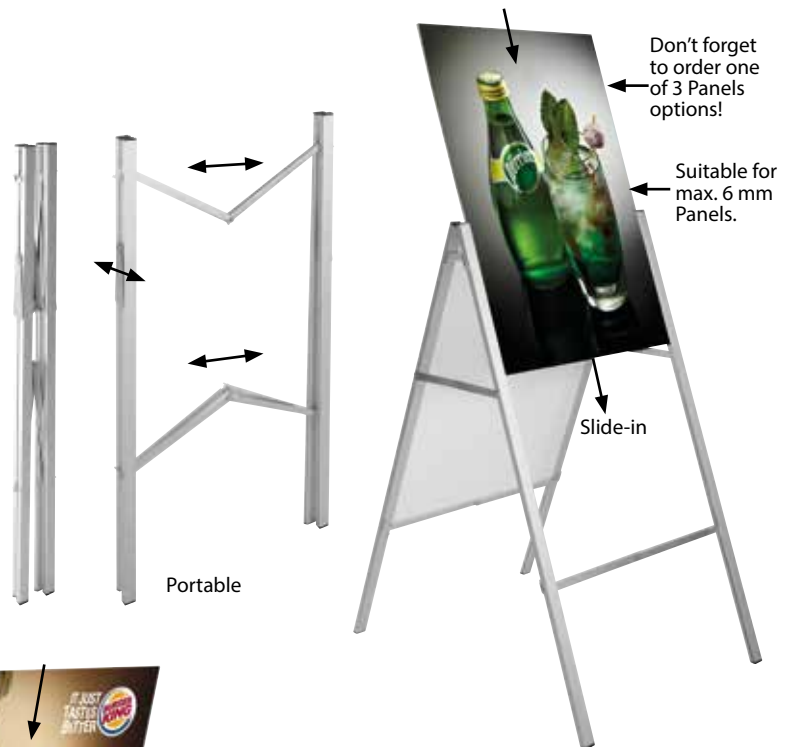

Easy Go

MATERIAL : Silver anodised aluminium		PANELS			
ARTICLE	POSTER	CHALK PANEL	WRITE-ON PANEL	PVC FOAM PANEL	SIZE
UABEG00NA1	594 X 841 mm	UYPEG100A1	UYPEG200A1	UYPEG300A1	594 X 841 mm
UABEG00NB2	500 X 700 mm	UYPEG100B1	UYPEG200B1	UYPEG300B1	500 X 700 mm
UABEG00NB1	700 X 1000 mm	UYPEG100B2	UYPEG200B2	UYPEG300B2	700 X 1000 mm
UABEG00N22	559 X 711 mm	UYPEG10022	UYPEG20022	UYPEG30022	559 X 711 mm
UABEG00N24	610 X 914 mm	UYPEG10024	UYPEG20024	UYPEG30024	610 X 914 mm

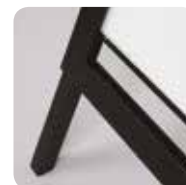
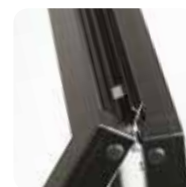

Slide-in

MATERIAL : Powder coated aluminium		
GRAY	BLACK	POSTER
UABSON00A1	UABSOB00A1	594 X 841 mm
UABSON00B1	UABSOB00B1	700 X 1000 mm





A new stunning look for pavement signs, it consists of 2 main articles, one of which serves the frame while the other supports the base of the product. It is practical to change the poster. It can be easily loaded, has no sharp edges and has steel springs for flexibility. The spring connectors stabilize the position of your poster. poster use is double sided.

PRO SERIES

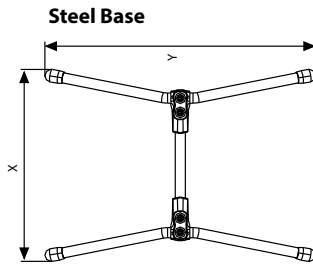

STEEL BASE

ARTICLE	SIZE (x-y)	DESCRIPTION
UTSM004000	890 X 1420 mm	X Large-Grey
UTSM004010	890 X 1420 mm	X Large-Black
UTSM003000	890 X 1260 mm	Large-Grey
UTSM003010	890 X 1260 mm	Large-Black
UTSM002000	690 X 1070 mm	Medium-Grey
UTSM002010	690 X 1070 mm	Medium-Black
UTSM001000	690 X 920 mm	Small-Grey
UTSM001010	690 X 920 mm	Small-Black

ROTO WATERBASE

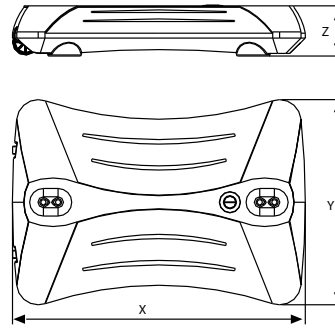

ROTO WATERBASE

ARTICLE	SIZE (x-y-z)	DESCRIPTION
UTWM002000	900 X 630 X 155 mm	Large-Grey
UTWM002010	900 X 630 X 155 mm	Large-Black
UTWM001000	720 X 580 X 155 mm	Small-Grey
UTWM001010	720 X 580 X 155 mm	Small-Black

NEWTECH WATERBASE

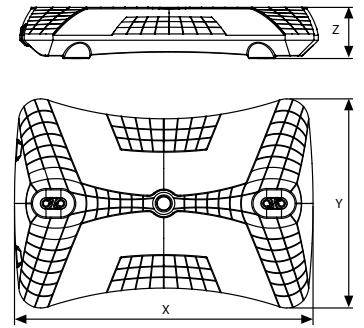

NEWTECH WATERBASE

ARTICLE	SIZE (x-y-z)	DESCRIPTION
UTWM004000	900 X 630 X 155 mm	Large-Grey
UTWM004010	900 X 630 X 155 mm	Large-Black
UTWM003000	720 X 530 X 155 mm	Small-Grey
UTWM003010	720 X 530 X 155 mm	Small-Black

Plus Header

Lite Header

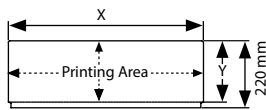

HEADER: 3 mm PVC Foam

ARTICLE	PRINTING AREA (x-y)
UYFT0050A1	671 X 200 mm
UYFT0050A0	918 X 200 mm
UYFT0050B2	577 X 200 mm
UYFT0050B1	777 X 200 mm
UYFT005022	635 X 200 mm
UYFT005023	585 X 200 mm
UYFT005024	687 X 200 mm
UYFT005034	839 X 200 mm
UYFT0050F0	877 X 200 mm

HEADER: 3 mm PVC Foam

ARTICLE	PRINTING AREA (x-y)
UYFT0040A1	632 X 200 mm
UYFT0040A0	879 X 200 mm
UYFT0040B2	538 X 200 mm
UYFT0040B1	738 X 200 mm
UYFT004022	597 X 200 mm
UYFT004024	648 X 200 mm
UYFT004034	800 X 200 mm
UYFT004084	750 X 200 mm

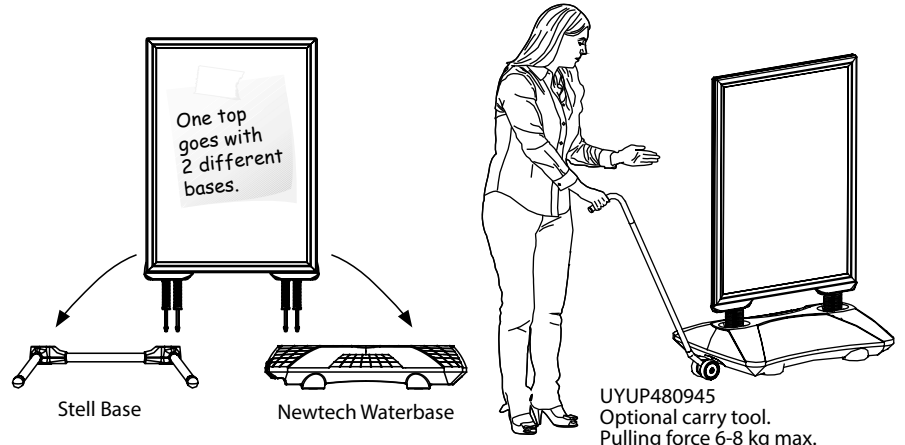

UYUP480945
Optional carry tool.
Pulling force 6-8 kg max.



SwingPro® Lite

STEEL BASE : Silver anodised aluminium

SILVER	BLACK	SIZE	FOR
UTSM001000	UTSM001010	920 mm	22" X 28" B2
UTSM002000	UTSM002010	1070 mm	A1 24" X 36"
UTSM003000	UTSM003010	1260 mm	B1 30" X 40" 28" X 44"
UTSM004000	UTSM004010	1420 mm	A0

Patent No: OHIM DM/084 128

FRAME : Silver anodised aluminium

SILVER	BLACK	POSTER
USWPL00NA1	USWPL00BA1	594 X 841 mm
USWPL00NA0	USWPL00BA0	841 X 1189 mm
USWPL00NB1	USWPL00BB1	700 X 1000 mm
USWPL00NB2	USWPL00BB2	500 X 700 mm
USWPL00N22	USWPL00B22	559 X 711 mm
USWPL00N24	USWPL00B24	610 X 915 mm
USWPL00N34	USWPL00B34	762 X 1016 mm
USWPL00N84	USWPL00B84	711 X 1117 mm

WindPro® Lite

NEWTECH WATER BASE

SILVER	BLACK	SIZE	FOR
UTWM003000	UTWM003010	720 X 530 mm	22" X 28" 24" X 36" A1 B2
UTWM004000	UTWM004010	900 X 630 mm	28" X 44" 30" X 40" B1 A0



UYUP480945
Optional
carry tool.



SwingPro® Plus

STEEL BASE : Silver anodised aluminium			
SILVER	BLACK	SIZE	FOR
UTSM001000	UTSM001010	920 mm	20"X30" 22"X28" B2
UTSM002000	UTSM002010	1070 mm	A1 24"X36"
UTSM003000	UTSM003010	1260 mm	B1 30"X40" F0
UTSM004000	UTSM004010	1420 mm	A0

Patent No: OHIM DM/084 128

FRAME : Silver anodised aluminium		
SILVER	BLACK	POSTER
USWPP00NA1	USWPP00BA1	594 X 841 mm
USWPP00NA0	USWPP00BA0	841 X 1189 mm
USWPP00NB1	USWPP00BB1	500 X 700 mm
USWPP00NB2	USWPP00BB2	700 X 1000 mm
USWPP00N23	USWPP00B23	508 X 762 mm
USWPP00N34	USWPP00B34	762 X 1016 mm
USWPP00N22	USWPP00B22	559 X 711 mm
USWPP00N24	USWPP00B24	610 X 915 mm
USWPP00NF0	USWPP00BF0	841 X 1321 mm

WindPro® Plus

NEWTECH WATER BASE			
SILVER	BLACK	SIZE	FOR
UTWM003000	UTWM003010	720 X 530 mm	20"X30" 22"X28" 24"X36" B2 A1
UTWM004000	UTWM004010	900 X 630 mm	30"X40" B1 A0 F0



Patent No: OHIM DM/084 128



UYUP480945
Optional
carry tool.



Slide-in SwingPro

STEEL BASE : Powder coated aluminium			
SILVER	BLACK	SIZE	FOR
UTSM002000	UTSM002010	690 X 1070 mm	559 X 711 mm
UTSM002000	UTSM002010	690 X 1070 mm	610 X 914 mm
UTSM003000	UTSM003010	890 X 1260 mm	686 X 1016 mm

FRAME : Silver anodised aluminium		
SILVER	BLACK	POSTER
USWS000N22	USWS000B22	559 X 711 mm
USWS000N24	USWS000B24	610 X 914 mm
USWS000N74	USWS000B74	686 X 1016 mm

Slide-in WindPro

NEWTECH WATER BASE			
SILVER	BLACK	SIZE	FOR
UTWM003000	UTWM003010	720 X 580 X 155 mm	559 X 711 mm
UTWM003000	UTWM003010	720 X 580 X 155 mm	610 X 914 mm
UTWM004000	UTWM004010	900 X 630 X 155 mm	686 X 1016 mm

Illuminated WindPro With Led

A unique solution as a Pavement Sign with battery

MATERIAL : Silver & Black powder coated frame & waterbase

ARTICLE	POSTER
USWL000A1	594 X 841 mm

Patent No: OHIM DM/084 128



Switch mode of lighting



WindPro tool UYUP480945 Included in each box.

TZZZ998701 Cable lock kit for WindPro 2100mm



- Street SignPro Frame with lens has a frame with lens and without lens. This unique feature helps keeping the poster in place sturdily.
- Street SignPro Frame without lens allows using rigid graphic.
- Street SignPro Board is for laminating self adhesive sticker.

STREET SIGNPRO

MATERIAL: PE			
WHITE	BLACK	SIZE	DESCRIPTION
UPSP110024	UPSP120024	610 X 915 mm	Street SignPro Poster with Lens
UPSP210024	UPSP220024	610 X 915 mm	Street SignPro Poster without Lens
UPSP310024	UPSP320024	610 X 915 mm	Street SignPro Board

Patent No: PCT/EP2017/052765



Poster case opener



Adhesive poster tape



Street SignPro Poster with Lens - Black

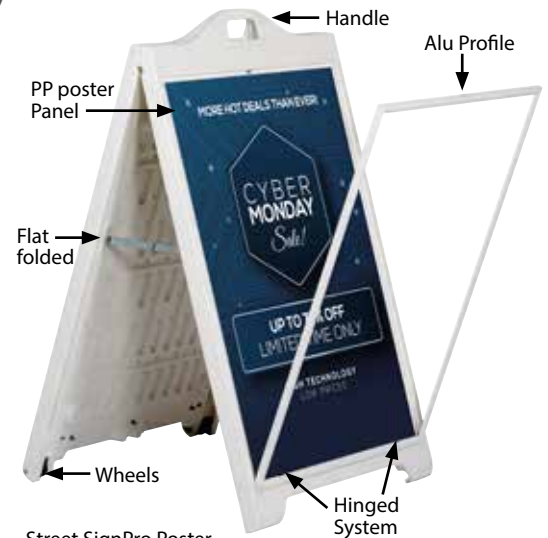

Street SignPro Poster without Lens - White



Street SignPro Board - Black



Various Sizes are available all with Mitred corners. After the closure of the side profiles, the rubber seal inside the wind sign in addition with over Size PET makes the product waterproof. The easy-to-open snap frame includes an anti-reflex cover suitable for external use when equipped with a water wick. Product is double sided. The steel springs provide the flexibility to ensure stability. The wheels enable the movement of the units.

SWINGMASTER & WATERBASE WIND SIGN



Safe corner

Header optional accessories

Water tank

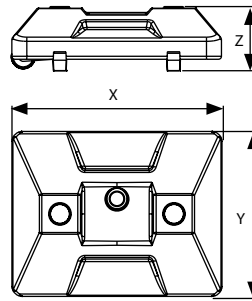
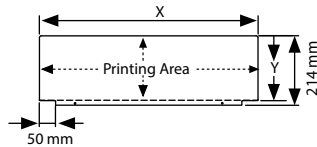

HEADER: 3 mm PVC Foam

ARTICLE	PRINTING AREA (x-y)
UYFT0050A2	479 X 200 mm
UYFT0050A1	671 X 200 mm
UYFT0050A0	918 X 200 mm
UYFT0050B2	577 X 200 mm
UYFT0050B1	777 X 200 mm
UYFT0050B0	1077 X 200 mm
UYFT005022	635 X 200 mm
UYFT005023	585 X 200 mm
UYFT005024	687 X 200 mm
UYFT005034	839 X 200 mm
UYFT005046	1093 X 200 mm

WIND SIGN BASE

ARTICLE	SIZE (x-y-z)	DESCRIPTION
UYUP406820	700 X 550 X 210 mm	Small base
UYUP406810	820 X 650 X 210 mm	Medium Base
UYUP406840	1000 X 750 X 210 mm	Large Base

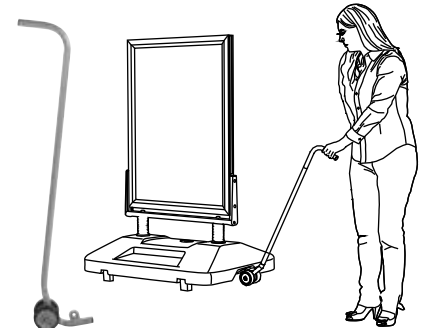

UYUP480945
Optional carry tool.
Pulling force 6-8 kg max.



Waterbase Wind Sign

MATERIAL : Silver anodised aluminium

ARTICLE	POSTER
UWWM000A2	420 X 594 mm
UWWM000A1	594 X 841 mm
UWWM000A0	841 X 1189 mm
UWWM000B2	500 X 700 mm
UWWM000B1	700 X 1000 mm
UWWM000B0	1000 X 1400 mm
UWWM000N23	508 X 762 mm
UWWM000N34	762 X 1016 mm
UWWM000N46	1016 X 1524 mm



Eco Waterbase Wind Sign

MATERIAL : Silver anodised aluminium

ARTICLE	POSTER
UEWM000A2	420 X 594 mm
UEWM000A1	594 X 841 mm
UEWM000A0	841 X 1189 mm
UEWM000B2	500 X 700 mm
UEWM000B1	700 X 1000 mm
UEWM000B0	1000 X 1400 mm
UEWM000N22	559 X 711 mm
UEWM000N23	508 X 762 mm
UEWM000N24	610 X 915 mm
UEWM000N34	762 X 1016 mm
UEWM000N46	1016 X 1524 mm



Swingmaster

MATERIAL : Silver anodised aluminium

ARTICLE	POSTER
UASM000A2	420 X 594 mm
UASM000A1	594 X 841 mm
UASM000A0	841 X 1189 mm
UASM000B2	500 X 700 mm
UASM000B1	700 X 1000 mm
UASM000B0	1000 X 1400 mm
UASM000N23	508 X 762 mm
UASM000N34	762 X 1016 mm
UASM000N46	1016 X 1524 mm



Eco Swingmaster

MATERIAL : Silver anodised aluminium

ARTICLE	POSTER
UESM000A2	420 X 594 mm
UESM000A1	594 X 841 mm
UESM000A0	841 X 1189 mm
UESM000B2	500 X 700 mm
UESM000B1	700 X 1000 mm
UESM000B0	1000 X 1400 mm
UESM000N22	559 X 711 mm
UESM000N23	508 X 762 mm
UESM000N24	610 X 915 mm
UESM000N34	762 X 1016 mm
UESM000N46	1016 X 1524 mm



- Designed and patented in UK.
- Assembled in a few seconds without tools.
- Unique hanging straps enable simple Panel interchange without tools.
- Flat packed, instruction sheet included.
- poster Panel options.
- Quick & easy poster change.
- Standart base colour in Black.

SWINGERS

NO TOOLS ASSEMBLY



Produced under license of
Des. Reg. No.2071096
European Patent No. EP0809227

2000 Poster

MATERIAL: Silver anodised aluminium

ARTICLE	POSTER
USW2000A2	420 X 594 mm



2000 Panel

MATERIAL: Silver anodised aluminium

ARTICLE	PRINTING AREA
USW2000N75	500 X 750 mm



A1 Size



B2 Size

Coloured Base



RAL 9005



RAL 3000



RAL 7045

3000 Poster

MATERIAL: Silver anodised aluminium

ARTICLE	POSTER
USW3000A1	594 X 841 mm
USW3000B2	500 X 700 mm



A Board
Maximum water capacity is 5 liter.



Provide lift of the sign



Pyramid
Maximum water capacity is 4,5 liter.



Stable, heavy and durable pavement sign. Suitable to set aside in parking areas, play grounds, shop entrances and busy pavement roads; especially for windy areas. Standard in metallic RAL 9006 color. By opening the plastic stoppers, you can pour in either water or sand to make the stand heavier.

WATERBASE PAVEMENT SIGNS

MATERIAL: High density polietilen

ARTICLE	MODEL	WEIGHT WITH WATER
UWPS005000	Pyramit	5,5 kg
UWPS001000	A Board	8 kg



Simple plastic pavement board for multiple purposes. PS Display has options for printing & lamination and chalk. Easy to move and store. Chalk option is suitable to write on with waterbase chalk pens.

PS BOARDS



MATERIAL: Polystyrene			
ARTICLE	SIZE	PRINTING AREA	MODEL
UPYP000000	500 X 880 mm	480 X 815 mm	PS Board
UPYPE00000	500 X 880 mm	480 X 815 mm	Carry PS Board
UPYP001000	500 X 880 mm	480 X 815 mm	PS Chalk Board

Don't forget to order Chalkboard Marker
UYAKLM1251 - Colour Marker
UYAKLM1250 - White Marker



Carry PS Board

PS Chalk Board



Stable & heavy pavement sign, used from both sides. There is a magnetic cover placed over the poster. Suitable for highly frequented public areas.

MAGNETIC IRON A BOARDS

Round

MATERIAL: Steel		
ARTICLE	POSTER	HEADER (x-y)
UABD255NA2	420 X 594 mm	420 X 240 mm
UABD255NA1	594 X 841 mm	594 X 327 mm
UABD255NB2	500 X 700 mm	500 X 280 mm
UABD255NB1	700 X 1000 mm	700 X 380 mm
UABD255N23	508 X 762 mm	508 X 284 mm
UABD255N34	762 X 1016 mm	762 X 411 mm

Rectangular

MATERIAL: Steel			
WITH HEADER	WITHOUT HEADER	POSTER	HEADER (x-y)
UABD211NA2	UABD210NA2	420 X 594 mm	450 X 175 mm
UABD211NA1	UABD210NA1	594 X 841 mm	624 X 175 mm
UABD211NB2	UABD210NB2	500 X 700 mm	530 X 175 mm
UABD211NB1	UABD210NB1	700 X 1000 mm	730 X 175 mm
UABD211N23	UABD210N23	508 X 762 mm	538 X 175 mm



Header

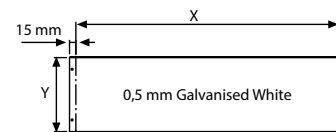

A double-sided customer stopper, practical to change the poster within. A1, 500x700 mm, 700x1000 mm Sizes are available. 32 mm profile, snap frame.

AL MAKI

MATERIAL: Silver anodised aluminium		
ROUND ARTICLE	MITRED ARTICLE	POSTER
UAM321CNA1	UAM325CNA1	594 X 841 mm
UAM321CNB2	UAM325CNB2	500 X 700 mm
UAM321CNB1	UAM325CNB1	700 X 1000 mm





With their waterproof and fade resistant feature, Wood displays are suitable for outdoor use. Yet remarkably their surfaces can be easily cleared of materials such as glass and plastics. This helps you to change your messages or prices. Our standard pen sets are defined next with the colors inside.

WOOD DISPLAY



Easy Wood Frame

MATERIAL: Fir Wood		
ARTICLE	SIZE	DESCRIPTION
UWFF010034	300 X 400 mm	Black Chalkboard
UWFF010046	400 X 600 mm	Black Chalkboard
UWFF010049	400 X 900 mm	Black Chalkboard
UWFF010068	600 X 800 mm	Black Chalkboard
UWFF010061	600 X 1150 mm	Black Chalkboard
UWFF010081	800 X 1200 mm	Black Chalkboard



Don't forget to order Chalkboard Marker UYAKLM1251 - Colour Marker UYAKLM1250 - White Marker

Black hinges



Foldable



Soft feet

Frameless Wooden Frame

MATERIAL: Beech Wood		
ARTICLE	SIZE	DESCRIPTION
UWFF010034	300 X 400 mm	Black Chalkboard
UWFF010046	400 X 600 mm	Black Chalkboard
UWFF010049	400 X 900 mm	Black Chalkboard
UWFF010068	600 X 800 mm	Black Chalkboard
UWFF010061	600 X 1150 mm	Black Chalkboard
UWFF010081	800 X 1200 mm	Black Chalkboard



Wooden Stopper

MATERIAL: Fir Wood		
ARTICLE	SIZE	DESCRIPTION
UWSR110068	600 X 800 mm	Black chalkboard, massive wood

Wooden Host

MATERIAL: Fir Wood		
ARTICLE	SIZE	DESCRIPTION
UWHT010068	600 X 800 mm	Black chalkboard, solid wood



ACP backing

Solid wood

Wood A Board Indoor

MATERIAL: Beech Wood		
ARTICLE	SIZE	DESCRIPTION
UWID006078	600 X 780 mm	Black chalkboard, solid wood



MDF backing

Solid wood

Wood A Board Outdoor

MATERIAL: Beech Wood		
ARTICLE	SIZE	DESCRIPTION
UWOD006078	600 X 780 mm	Black chalkboard, solid wood



Retractable crowd control system, Q Belts, is ready to use in place which offers a choice of post finishes combined with a selection of belt colours. It is suitable to be used wherever people come together such as airports, cinema halls, hotels, museums etc. 4 way pole provides the flexibility to create the optimum pedestrian flow. Q Belt and Q Belt Basic is offered to suit different budget request. Both are constructed from sturdy, durable Stainless Steel and features with rubberized and heavy base.

Q BELT SYSTEM

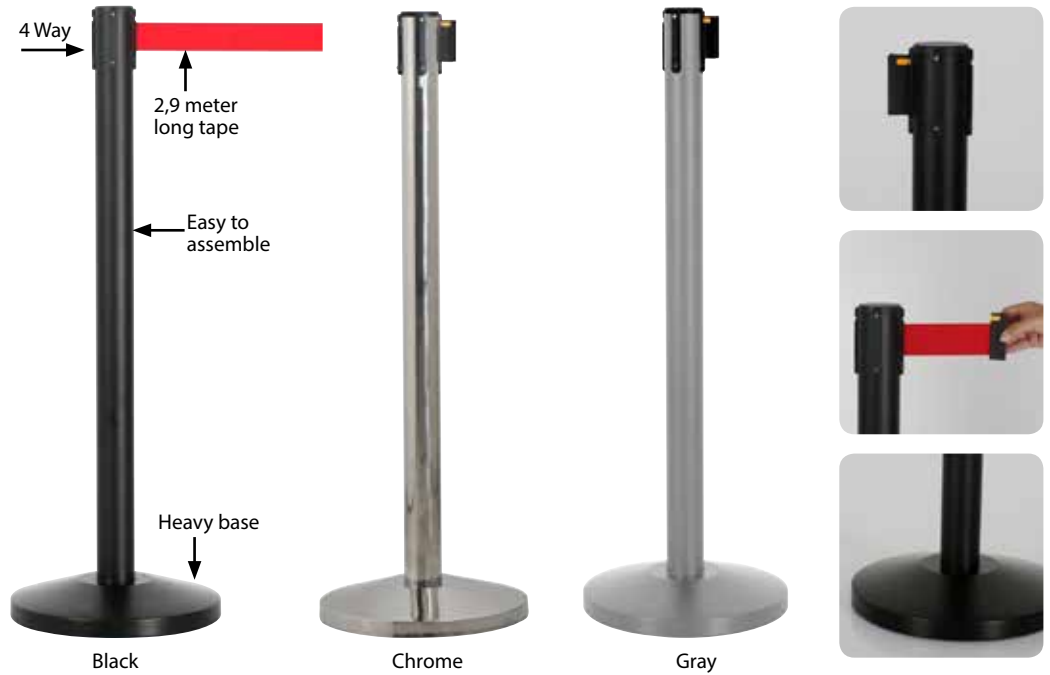

Q Belt

MATERIAL: Steel post

ARTICLE	DESCRIPTION
UQBL01BB00	Black-Black Tape
UQBL01BR00	Black-Red Tape
UQBL01BL00	Black-Blue Tape
UQBL01GB00	Grey-Black Tape
UQBL01GR00	Grey-Red Tape
UQBL01GL00	Grey-Blue Tape
UQBL01CB00	Chrome-Black Tape
UQBL01CR00	Chrome-Blue Tape
UQBL01CL00	Chrome-Red Tape

Choice of 3 Belt colours:



For Wall

MATERIAL: Steel

ARTICLE	DESCRIPTION
UQBL0WC000	Black wall connection



Accessories available!

Available only A4 Landscape & Portrait



Header Sign Frame

Header Acrylic

HEADER: Sign frame

ARTICLE	DESCRIPTION
TWBSFH0305	Horizontal, Black A4
TWBSFV0305	Vertical, Black A4
TWBASF0405	Adaptor Of Sign Frame



HEADER: Acrylic

ARTICLE	DESCRIPTION
UQBL0011A4	Portrait, A4
UQBL0012A4	Landscape, A4

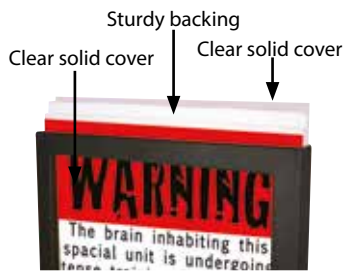



Strong and high quality Q Ropes are ready to use. It is constructed from sturdy, durable steel. 4-way pole provides flexibility for the use. Ideal in banks, hotels, receptions, retail shops and anywhere that required a crowd management system. Q Rope Basic, Q Rope Flat-top and Q Rope Knob-top offer different styles for different taste of the user. All incorporate twisted design barrier rope, which looks high quality and professional. and feature with rubberized heavy base.

Q ROPE SYSTEM



Blue-Chrome
Length 2m



Black-Chrome
Length 2m



Red-Chrome
Length 2m



Red-Gold
Length 3m

Choice of 3 Rope colours:

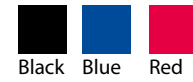

Black Blue Red

Flat Top

MATERIAL: Steel

ARTICLE	DESCRIPTION
UQRPP1B020	Black - Flat Top. W/out Weight W/out Rope
UQRPP1G020	Grey - Flat Top. W/out Weight W/out Rope
UQRPP1C020	Chrome - Flat Top. W/out Weight W/out Rope
UQRPP1W020	White - Flat Top. W/out Weight W/out Rope
UQRPOOL000	Blue-Chrome / only rope
UQRPOOB000	Black-Chrome / only rope
UQRPOOR000	Red-Chrome / only rope
TWBTRT0201	Red-Gold / only rope

Knob Top

MATERIAL: Steel

ARTICLE	DESCRIPTION
UQRPP1B010	Black - Knob Top. W/out Weight W/out Rope
UQRPP1G010	Grey - Knob Top. W/out Weight W/out Rope
UQRPP1C010	Chrome - Knob Top. W/out Weight W/out Rope
UQRPP1W010	White - Knob Top. W/out Weight W/out Rope
UQRPOOL000	Blue-Chrome / only rope
UQRPOOB000	Black-Chrome / only rope
UQRPOOR000	Red-Chrome / only rope
TWBTRT0201	Red-Gold / only rope

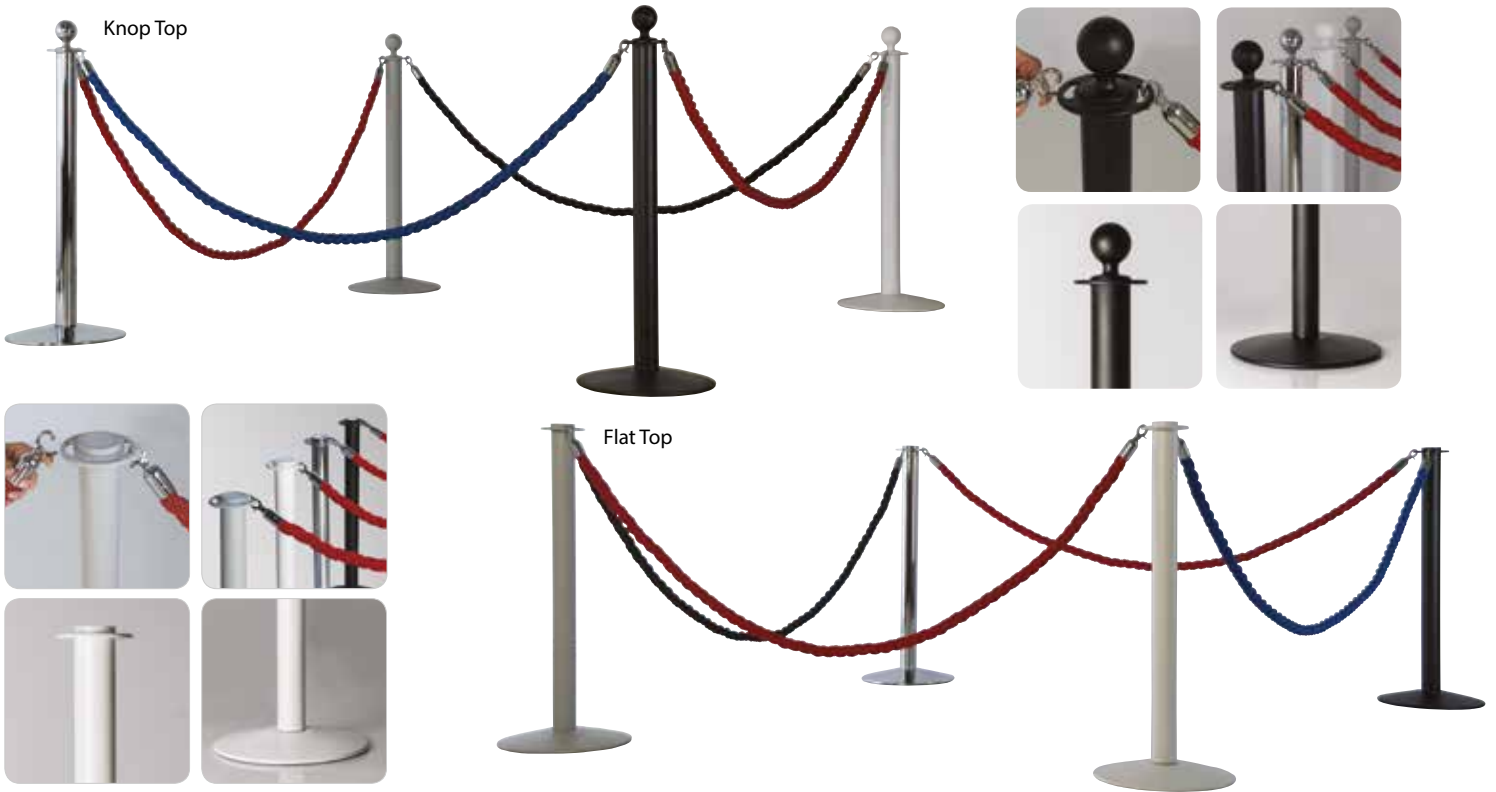



Offering so many different styles, colours and materials, customers has options for their budget, environment and taste. Choose the material, colour and one of rectangular or oval base, choose the number of poster you want to display, you are ready to go!

INFO STANDS

Color options

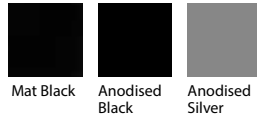

PP/PET Panel

MATERIAL: PP - 0,6 mm PET		
ARTICLE	SIZE	DESCRIPTION
UYPIBM0118	457 X 610 mm	PP - Gray
UYPIBM0116	457 X 1524 mm	PP - Gray
UYPIBM0122	559 X 711 mm	PP - Gray
UYPIBM0126	559 X 1727 mm	PP - Gray
UYPIBM01A1	594 X 841 mm	PP - Gray
UYPIBM0218	457 X 610 mm	PET 0,6 mm
UYPIBM0218	559 X 1524 mm	PET 0,6 mm
UYPIBM0222	559 X 711 mm	PET 0,6 mm
UYPIBM0226	559 X 1727 mm	PET 0,6 mm
UYPIBM02A1	594 X 841 mm	PET 0,6 mm

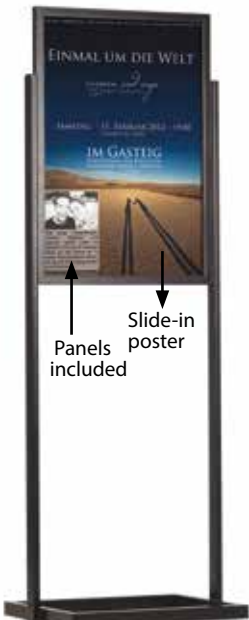

Eco / 1 Tier - Black



Eco / 2 Tier - Black



Eco / 500 X 1700 mm - Black

Panels included



Eco

MATERIAL: Silver & Black aluminium		
ARTICLE	POSTER	DESCRIPTION
UIBS00N151	500 X 1700 mm	Silver anodised
UIBS00C151	500 X 1700 mm	Black powder coated
UIBS00N1A1	594 X 841 mm	1 Tier - Silver anodised
UIBS00N1B2	500 X 700 mm	1 Tier - Silver anodised
UIBS00C1A1	594 X 841 mm	1 Tier - Black powder coated
UIBS00C1B2	500 X 700 mm	1 Tier - Black powder coated
UIBS00N2A1	594 X 841 mm	2 Tier - Silver anodised
UIBS00N2B2	500 X 700 mm	2 Tier - Silver anodised
UIBS00C2A1	594 X 841 mm	2 Tier - Black powder coated
UIBS00C2B2	500 X 700 mm	2 Tier - Black powder coated

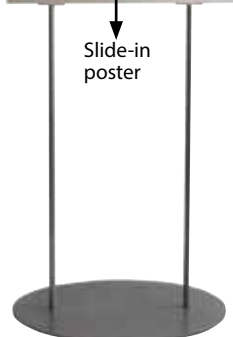

Oval / Hammered Gray

Panels included

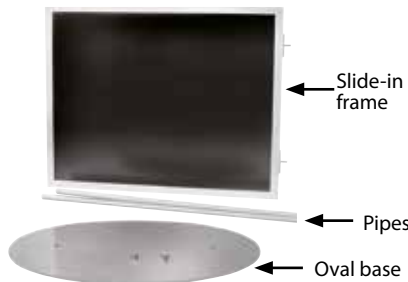

Oval

MATERIAL: Silver & Black anodised aluminium		
SILVER	BLACK	POSTER
UIBS10N0A2	UIBS10B0A2	420 X 594 mm
UIBS10N0A1	UIBS10B0A1	594 X 841 mm
UIBS10N0B2	UIBS10B0B2	500 X 700 mm
UIBS10N0Z3	UIBS10B0Z3	508 X 762 mm



Infoboard

MATERIAL: Silver anodised aluminium		
SINGLE SIDED	DOUBLE SIDED	POSTER
UIB200TNA1	UIB200CNA1	594 X 841 mm
UIB200TNB2	UIB200CNB2	500 X 700 mm
UIB200TNB1	UIB200CNB1	700 X 1000 mm



Ultra Slim "SMART LEDBOX"



We offer single and double sided LED illuminated frames to use indoor or outdoor. You will have the choice for snap profiles or magnetic covers. All are complete with powersupplies and wall hanger or suspension kit. What ever you decide, they are ready to use. LED illuminated technology offers high illumination so that you attract people to your message.

LEDBOXES

Profile Type

25 mm

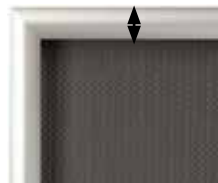

Model

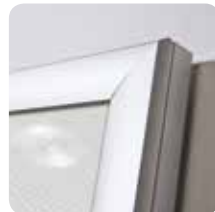

Single sided

Hanger



2 wall hangers are standard in each product. Moving hangers let the mounting in Portrait and Landscape position.

35 mm

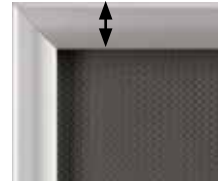

Double sided



Standard hanging kit for all Sizes: 2 meters x 2 pcs wire cable and 2 ceiling hangers.

On/Off switch →

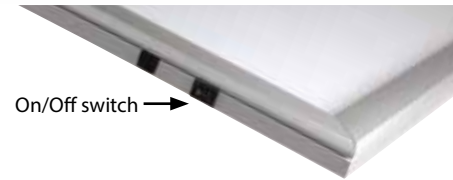

Dimmer



Optional dimmer to go with LED illuminated frame.. Simply jack the dimmer in frame and then into powersupply. It adjust the light from dark to max lux of LED illuminated frame.



- Improved Led technology for improved luminance.
- Pre-treated light guided Panel diffuses light even & powerful.
- CE & UL listed electrical components.
- Offers evenly diffused lux in all Sizes.
- Snap - open frame for easy poster change.
- Saves up to 60% from energy costs.

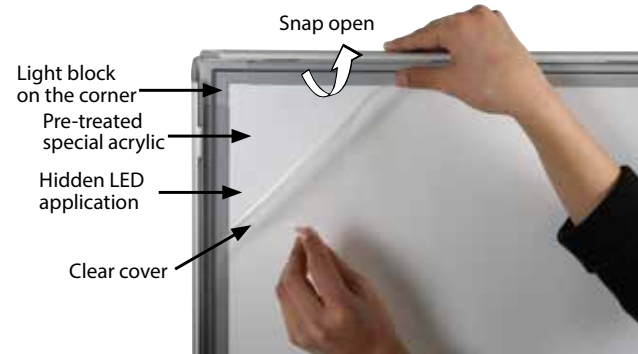
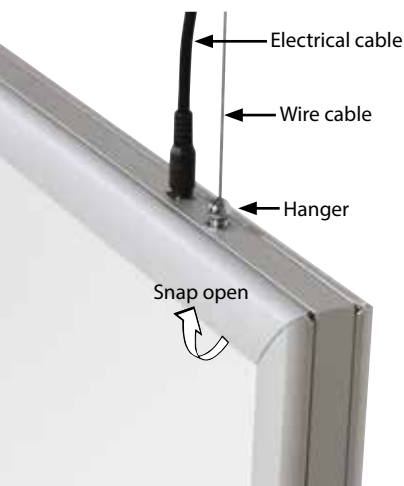

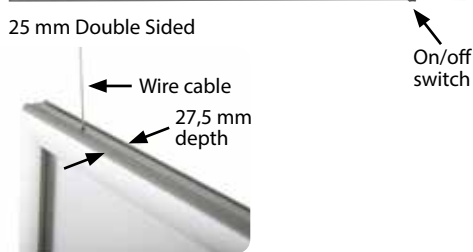
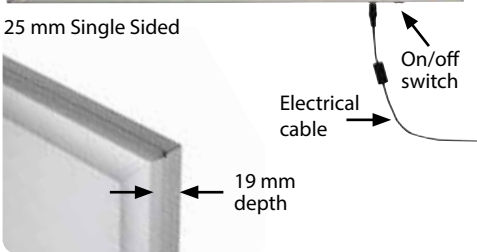

25 mm Single Sided

MATERIAL : Silver anodised aluminium		
ARTICLE	POSTER	LIGHTING
ULD25TN0A4	210 X 297 mm	1700-2000 LUX
ULD25TN0A3	297 X 420 mm	3300-3600 LUX
ULD25TN0A2	420 X 594 mm	3000-3300 LUX
ULD25TN0A1	594 X 841 mm	2700-3000 LUX
ULD25TN0B2	500 X 700 mm	2900-3200 LUX
ULD25TN0B1	700 X 1000 mm	2500-2800 LUX
ULD25TN023	508 X 762 mm	2900-3200 LUX
ULD25TN034	762 X 1016 mm	2500-2800 LUX



25 mm Double Sided

MATERIAL : Silver anodised aluminium		
ARTICLE	POSTER	LIGHTING
ULD25CNOA4	210 X 297 mm	1500-1800 LUX
ULD25CNOA3	297 X 420 mm	2000-2300 LUX
ULD25CNOA2	420 X 594 mm	1800-2000 LUX
ULD25CNOA1	594 X 841 mm	1600-1800 LUX
ULD25CNOB2	500 X 700 mm	1700-1900 LUX
ULD25CNO23	508 X 762 mm	1700-1900 LUX

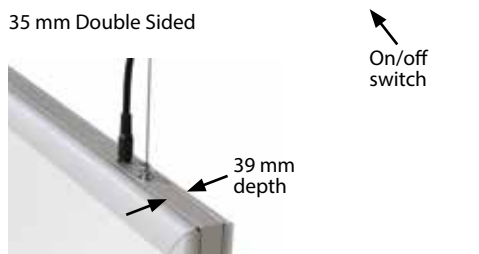
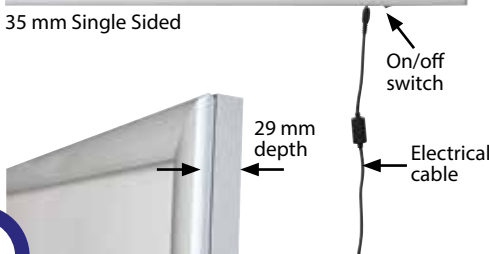
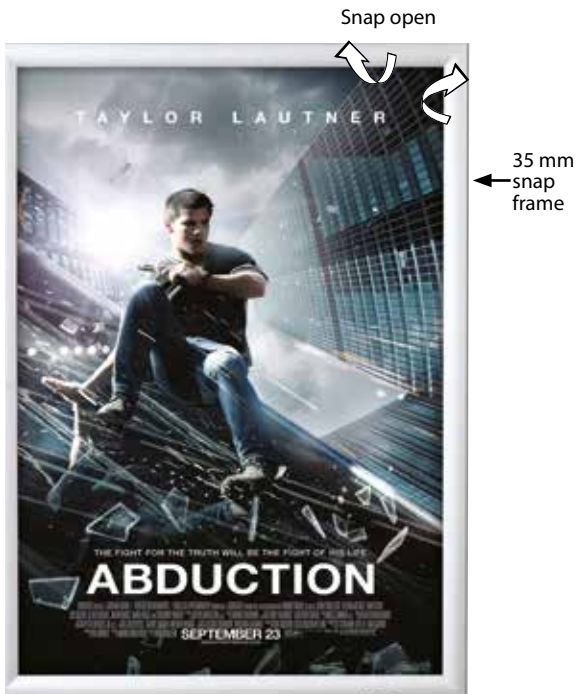

35 mm Single Sided

MATERIAL : Silver anodised aluminium		
ARTICLE	POSTER	LIGHTING
ULD35TN0A4	210 X 297 mm	4200-4500 LUX
ULD35TN0A3	297 X 420 mm	3900-4200 LUX
ULD35TN0A2	420 X 594 mm	3500-3900 LUX
ULD35TN0A1	594 X 841 mm	3000-3300 LUX
ULD35TN0A0	841 X 1189 mm	2500-2800 LUX
ULD35TN0B2	500 X 700 mm	3000-3300 LUX
ULD35TN0B1	700 X 1000 mm	2600-2900 LUX
ULD35TN0B0	1000 X 1400 mm	2000-2300 LUX
ULD35TN023	508 X 762 mm	3000-3300 LUX
ULD35TN034	762 X 1016 mm	2600-2900 LUX
ULD35TN046	1016 X 1524 mm	2000-2300 LUX



35 mm Double Sided

MATERIAL : Silver anodised aluminium		
ARTICLE	POSTER	LIGHTING
ULD35CNOA1	594 X 841 mm	2100-2400 LUX
ULD35CNOA0	841 X 1189 mm	1800-2100 LUX
ULD35CNOB1	700 X 1000 mm	2000-2300 LUX
ULD35CNOB0	1000 X 1400 mm	1500-1800 LUX
ULD35CNO34	762 X 1016 mm	2000-2300 LUX
ULD35CNO46	1016 X 1524 mm	1500-1800 LUX

Weatherproof Power Supply (IP67)

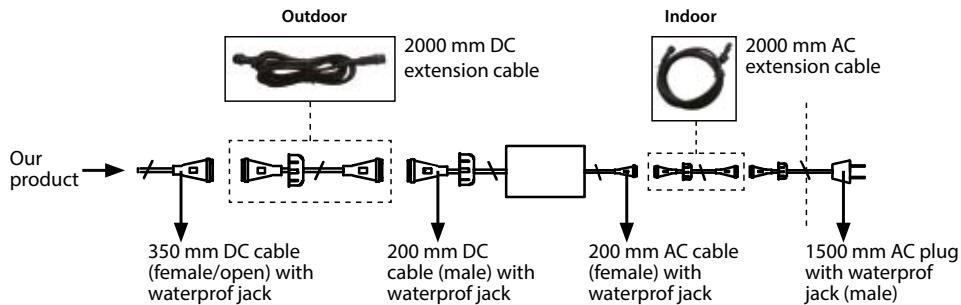

Mobile cable outlet, from the edge and from the back of the aluminum box.

- Improved Led technology and laser treatment.
- IP67 and CE listed electrical components.
- Offers evenly diffused lux in all Sizes.

Weatherproof , 35 mm Single Sided

MATERIAL : Silver anodised aluminium

ARTICLE	POSTER	LIGHTING
ULS35TN0A4	210 X 297 mm	2600-2900 LUX
ULS35TN0A3	297 X 420 mm	2700-3000 LUX
ULS35TN0A2	420 X 594 mm	1800-2100 LUX
ULS35TN0A1	594 X 841 mm	1600-1900 LUX
ULS35TN0A0	841 X 1189 mm	1200-1500 LUX
ULS35TN0B2	500 X 700 mm	1600-1900 LUX
ULS35TN0B1	700 X 1000 mm	1400-1700 LUX
ULS35TN0B0	1000 X 1400 mm	1000-1200 LUX
ULS35TN023	508 X 762 mm	1600-1900 LUX
ULS35TN034	762 X 1016 mm	1400-1700 LUX
ULS35TN046	1016 X 1524 mm	1000-1200 LUX

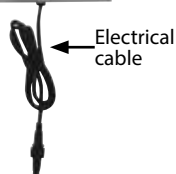

Water drainage holes



Electrical cable

Locking frame with allen key



Lockable Weatherproof, 35 mm, Single Sided

MATERIAL : Silver anodised aluminium

ARTICLE	POSTER SIZE	LIGHTING
ULH35TN0A4	210 X 297 mm	2600-2900 LUX
ULH35TN0A3	297 X 420 mm	2700-3000 LUX
ULH35TN0A2	420 X 594 mm	1800-2100 LUX
ULH35TN0A1	594 X 841 mm	1600-1900 LUX
ULH35TN0A0	841 X 1189 mm	1200-1500 LUX
ULH35TN0B2	500 X 700 mm	1600-1900 LUX
ULH35TN0B1	700 X 1000 mm	1400-1700 LUX
ULH35TN0B0	1000 X 1400 mm	1000-1200 LUX
ULH35TN023	508 X 762 mm	1600-1900 LUX
ULH35TN034	762 X 1016 mm	1400-1700 LUX
ULH35TN046	1016 X 1524 mm	1000-1200 LUX

Lock corner component

Sealing rubber

Hidden LED application

Pre-treated special acrylic

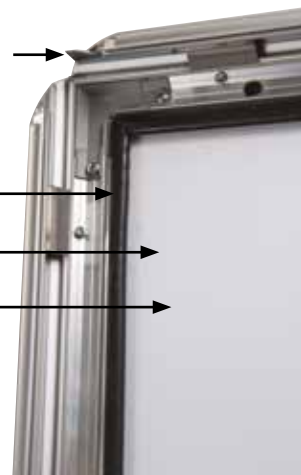

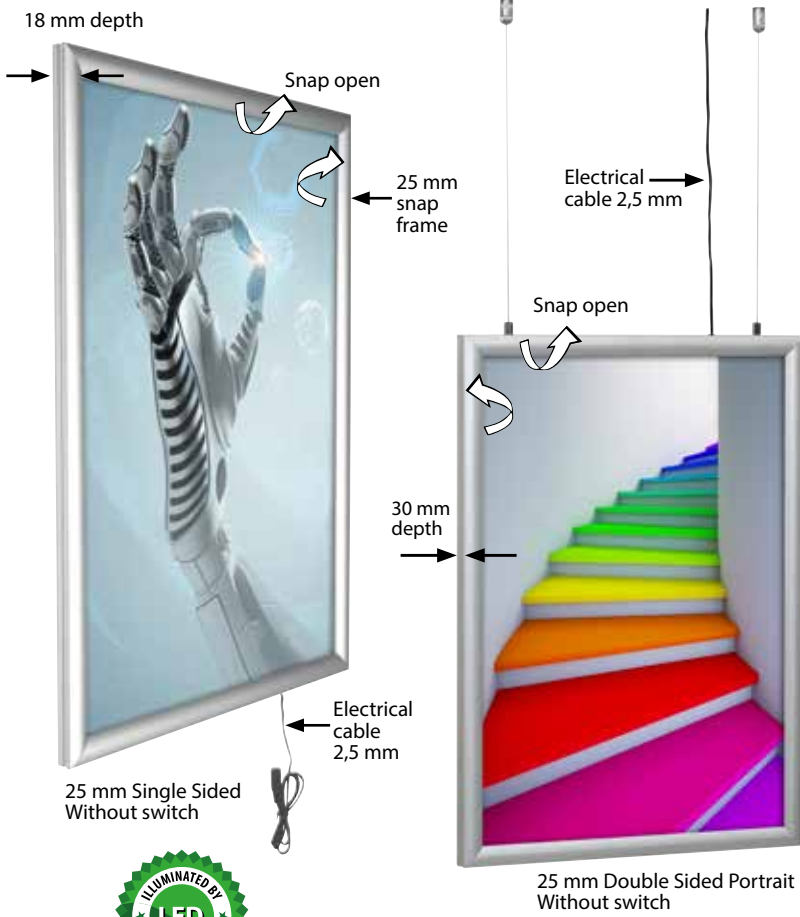

Best Buy LEDbox 25 mm Double Sided

MATERIAL : Silver anodised aluminium		
ARTICLE	POSTER SIZE	LIGHTING
ULB25TN0A4	210 X 297 mm	3000-3300 LUX
ULB25TN0A3	297 X 420 mm	2800-3000 LUX
ULB25TN0A2	420 X 594 mm	2400-2700 LUX
ULB25TN0A1	594 X 841 mm	1900-2100 LUX
ULB25TN0A0	841 X 1189 mm	1500-1800 LUX
ULB25TN0B2	500 X 700 mm	2100-2400 LUX
ULB25TN0B1	700 X 1000 mm	1700-2000 LUX
ULB25TN017	280 X 432 mm	2800-3000 LUX
ULB25TN022	559 X 712 mm	2000-2200 LUX
ULB25TN023	508 X 762 mm	2200-2500 LUX
ULB25TN024	610 X 915 mm	1900-2100 LUX
ULB25TN034	762 X 1016 mm	1700-2000 LUX

Best Buy LEDbox 25 mm Single Sided

MATERIAL : Silver anodised aluminium		
ARTICLE	POSTER SIZE	LIGHTING
ULB25TN0A4	210 X 297 mm	3000-3300 LUX
ULB25TN0A3	297 X 420 mm	2800-3000 LUX
ULB25TN0A2	420 X 594 mm	2400-2700 LUX
ULB25TN0A1	594 X 841 mm	1900-2100 LUX
ULB25TN0A0	841 X 1189 mm	1500-1800 LUX
ULB25TN0B2	500 X 700 mm	2100-2400 LUX
ULB25TN0B1	700 X 1000 mm	1700-2000 LUX
ULB25TN017	280 X 432 mm	2800-3000 LUX
ULB25TN022	559 X 712 mm	2000-2200 LUX
ULB25TN023	508 X 762 mm	2200-2500 LUX
ULB25TN024	610 X 915 mm	1900-2100 LUX
ULB25TN034	762 X 1016 mm	1700-2000 LUX

Landscape hanging grooves

Portrait hanging grooves

Suitable for use in landscape and portrait positions.



Open magnetic clear cover

Slide-in poster



Improved LED Technology & laser surface treatment

Magnetic clear cover

Clips to hold the poster



Magnetic Smart LEDbox: A new generation in LEDboxes. With a practical magnetic protection cover, it is very easy to change the poster. High illumination level attracts consumers to the message.

MAGNETIC SMART LEDBOX



MATERIAL : Silver anodised aluminium		
ARTICLE	POSTER	LIGHTING
ULDMON00A4	210 X 297 mm	5500-6000 LUX
ULDMON00A3	297 X 420 mm	5000-5400 LUX
ULDMON00A2	420 X 594 mm	4600-4900 LUX
ULDMON00A1	594 X 841 mm	3500-3800 LUX
ULDMON00A0	841 X 1189 mm	2800-3200 LUX
ULDMON00B2	500 X 700 mm	4000-4300 LUX
ULDMON00B1	700 X 1000 mm	3000-3300 LUX

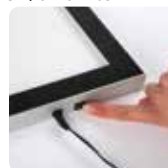



Very Slim, Magneco LEDbox is a new generation in LEDboxes. With a practical magnetic protection cover, it is very easy to change the poster. High and even illumination level attracts consumers to the message. Hidden finger hole to take off the acrylic cover prevents public access to the poster.

MAGNECO LEDBOX

Single Sided

MATERIAL : Silver anodised aluminium			
SILVER	BLACK	POSTER SIZE	LIGHTING
ULDMENOB4	ULDMEB0B4	210 X 297 mm	3000-3600 LUX
ULDMENOB3	ULDMEB0B3	297 X 420 mm	3000-3300 LUX
ULDMENOB2	ULDMEB0B2	420 X 594 mm	2700-3000 LUX
ULDMENOB1	ULDMEB0B1	594 X 841 mm	2300-2600 LUX
ULDMENOB0	ULDMEB0B0	841 X 1189 mm	1600-1800 LUX
ULDMENOB2	ULDMEB0B2	500 X 700 mm	2200-2500 LUX
ULDMENOB1	ULDMEB0B1	700 X 1000 mm	1800-2100 LUX
ULDMENOB17	ULDMEB0B17	280 X 432 mm	2800-3000 LUX
ULDMENOB22	ULDMEB0B22	559 X 712 mm	2000-2200 LUX
ULDMENOB23	ULDMEB0B23	508 X 762 mm	2200-2500 LUX
ULDMENOB24	ULDMEB0B24	610 X 915 mm	1900-2100 LUX
ULDMENOB34	ULDMEB0B34	762 X 1016 mm	1800-2100 LUX

Double Sided

MATERIAL : Silver anodised aluminium			
SILVER	BLACK	POSTER SIZE	LIGHTING
ULDMENCBA4	ULDMECBA4	210 X 297 mm	2800-3000 LUX
ULDMENCBA3	ULDMECBA3	297 X 420 mm	2400-2600 LUX
ULDMENCBA2	ULDMECBA2	420 X 594 mm	2100-2300 LUX
ULDMENCBA1	ULDMECBA1	594 X 841 mm	1800-2000 LUX
ULDMENCBA0	ULDMECBA0	841 X 1189 mm	1200-1400 LUX
ULDMENCBB2	ULDMECBB2	500 X 700 mm	2000-2200 LUX
ULDMENCBB1	ULDMECBB1	700 X 1000 mm	1600-1800 LUX
ULDMENCB17	ULDMECB17	280 X 432 mm	2400-2600 LUX
ULDMENCB22	ULDMECB22	559 X 712 mm	1900-2100 LUX
ULDMENCB23	ULDMECB23	508 X 762 mm	2000-2200 LUX
ULDMENCB24	ULDMECB24	610 X 915 mm	1800-2000 LUX
ULDMENCB34	ULDMECB34	762 X 1016 mm	1600-1800 LUX



Single Sided
Without switch

3,5 m jack cable

Finger hole to push cover



Dimmer



Optional dimmer to go with LED illuminated frame.. Simply jack the dimmer in frame and then into powersupply. It adjust the light from dark to max lux of LED illuminated frame.



2 wall hangers are standard in each product. Moving hangers let the mounting in Portrait and Landscape position.



13 mm depth

Magnets

Poster

2 mm acrylic cover

3&4 mm acrylic backing



Suitable for use in landscape and portrait positions.

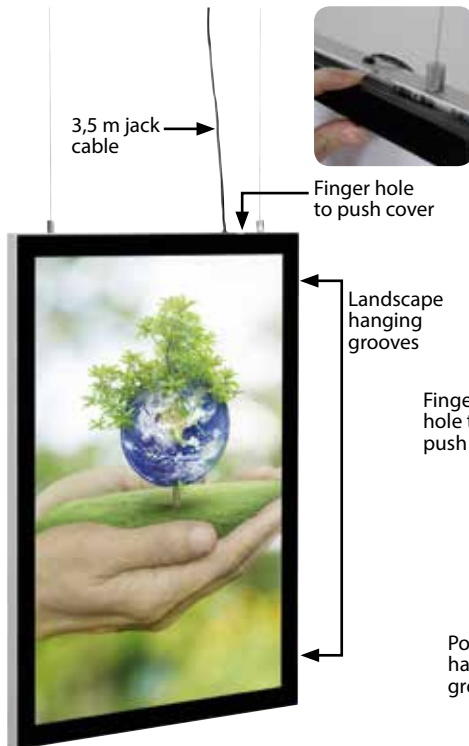

Double Sided Portrait -Without switch



Finger hole to push cover

Landscape hanging grooves

Finger hole to push cover

Portrait hanging grooves



Standard hanging kit for all Sizes: 2 meters x 2 pcs wire cable and 2 ceiling hangers.



Double Sided Landscape -Without switch

Hanger

3,5 m jack cable

20 mm depth

Magnets

Poster

2 mm acrylic cover





Modular alphabet with LED

The sockets to be used to collocate the letters are specially designed as Silver plated brass. Therefore it is resistant to corrosion and the relevant problems. The most important feature of modular letters is that LEDs' high lumen output with their 90.000 hrs lifetime.

Injection moulded letters are UV filtered and their colour will not fade away in case of direct sunlight exposure. Their printed circuit boards are double sided and epoxide.

The modular letters are impact modified and riveting method is used to prevent copper strips from being broken off. Products are for indoor use.

SMART LED LETTER

MATERIAL : Injected plastic

ARTICLE	LETTER	WIDTH	HEIGHT	THICKNESS
ULDORC001	A	112 mm	116 mm	14 mm
ULDORC002	B	94 mm	116 mm	14 mm
ULDORC003	C	102 mm	118 mm	14 mm
ULDORC005	D	100 mm	116 mm	14 mm
ULDORC006	E	87 mm	116 mm	14 mm
ULDORC007	F	87 mm	116 mm	14 mm
ULDORC008	G	112 mm	116 mm	14 mm
ULDORC010	H	97 mm	116 mm	14 mm
ULDORC011	I	42 mm	116 mm	14 mm
ULDORC013	J	47 mm	110 mm	14 mm
ULDORC014	K	100 mm	116 mm	14 mm
ULDORC015	L	83 mm	116 mm	14 mm
ULDORC016	M	115 mm	116 mm	14 mm
ULDORC017	N	98 mm	116 mm	14 mm
ULDORC018	O	118 mm	118 mm	14 mm
ULDORC020	P	95 mm	116 mm	14 mm
ULDORC021	R	109 mm	116 mm	14 mm
ULDORC022	S	103 mm	116 mm	14 mm
ULDORC024	T	97 mm	116 mm	14 mm
ULDORC025	U	105 mm	118 mm	14 mm
ULDORC027	V	109 mm	120 mm	14 mm
ULDORC028	Y	103 mm	120 mm	14 mm
ULDORC029	Z	95 mm	115 mm	14 mm
ULDORC030	Q	118 mm	118 mm	14 mm
ULDORC031	W	130 mm	120 mm	14 mm
ULDORC032	X	100 mm	116 mm	14 mm
ULDORC033	SPACE	87 mm	26 mm	14 mm
ULDORC034	&	130 mm	116 mm	14 mm
ULDORC035	%	120 mm	110 mm	14 mm
ULDORN000	0	105 mm	116 mm	14 mm
ULDORN001	1	80 mm	116 mm	14 mm
ULDORN002	2	100 mm	116 mm	14 mm
ULDORN003	3	100 mm	116 mm	14 mm
ULDORN004	4	115 mm	116 mm	14 mm
ULDORN005	5	105 mm	116 mm	14 mm
ULDORN006	6	100 mm	116 mm	14 mm
ULDORN007	7	95 mm	116 mm	14 mm
ULDORN008	8	105 mm	116 mm	14 mm
ULDORN009	9	105 mm	116 mm	14 mm
ULDORF000	BLINKER	65 mm	26 mm	14 mm
ULDORT000	ENDCAP	3 mm	22 mm	14 mm
ULDAR1020	ADAPTOR	-	-	-



- Practical Application
- Environmentalist solution
- Affordable
- LED Integration
- Highly Productive
- Very Noticeable



Individuel packing

Letters



Standard word combinations

PHARMACY CASH
 TAKEAWAY PIZZA
 UNISEX NAIL BAR
 OPEN 24 HR TAXI
 MARKET ENTRANCE
 CAR PARK CLOSED
 MASSAGE BURGERS
 BARBER SHOP EXIT
 FISH & CHIPS OPEN
 KIDS CLUB CAFE



Presentation Kit / UYUP480400





Ultra slim and clear Acryled. The edge-lit acryled mounts portrait or landscape for various types of signage. Edge-lit Acryled lights up poster in sizes of A4, A3, A2. Acryled lit with LEDs use less power than traditional illuminated signage. poster is placed in between the specially treated acrylic & cover acrylic sheet & fixed in position by two clear clips on two short sides. Products is available in 2 colours; silver and black. Compared to traditional articles in the market, Acryled provides easy poster change when unit keeps mounted on the wall.

ACRYLED FOR WALL MOUNTING



MATERIAL : Treated illuminated acrylic		
ARTICLE	POSTER	DESCRIPTION
UACLON00A4	210 X 297 mm	Square - Silver
UACLON00A3	297 X 420 mm	Square - Silver
UACLON00A2	420 X 594 mm	Square - Silver
UACLON00A1	594 X 841 mm	Square - Silver
UACLOB00A4	210 X 297 mm	Square - Black
UACLOB00A3	297 X 420 mm	Square - Black
UACLOB00A2	420 X 594 mm	Square - Black
UACLOB00A1	594 X 841 mm	Square - Black
UACLYN0000	Ø 446	Circle - Silver
UACLYB0000	Ø 446	Circle - Black
UAACLE0000	700 X 350 mm	Eliptical - Silver
UAACLEB0000	700 X 350 mm	Eliptical - Black



Single faced convex boxes are available in various Sizes. Access to poster is by snap frame profiles on each long side which are in 25mm. The surface is opal acrylic. Convex Lightbox includes a PET cover which is ideal to illuminate your duratrans & poster without reflection. For best results, use printings on backlit film or duratrans.

CONVEX LEDBOX

MATERIAL : Silver anodised aluminium	
ARTICLE	POSTER
UCLB25LNA4	210 X 297 mm
UCLB25LNA3	297 X 420 mm
UCLB25LNA2	420 X 594 mm
UCLB25LNA1	594 X 841 mm
UCLB25LNB2	500 X 700 mm
UCLB25LNB3	508 X 762 mm





We offer illuminated or non illuminated Totems. You can select any styles we offer you or customise your own Totem with decorative one. Choose the best for you.

TOTEMS

CE & UL approved.

LEDA Illuminated Magnetic Totem

MATERIAL: Silver anodised aluminium

ARTICLE	DESCRIPTION	POSTER	LIGHTING
UMLD37B000	Black	594 X 1682 mm	1900-2100 LUX
UMLD37N000	Silver	594 X 1682 mm	1900-2100 LUX



Sheet metal 6 mm, RAL 9006 coated



Finger hole to push cover



Magnetic

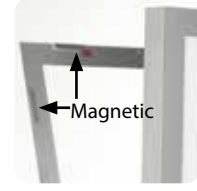

Slide-in clips



Mono with light

Mono

MATERIAL: Silver anodised aluminium

ARTICLE	POSTER	DESCRIPTION
UTTME10500	500 X 1700 mm	without light
UTTME10600	600 X 1700 mm	without light
UTTME00500	500 X 1700 mm	with light
UTTME00600	600 X 1700 mm	with light



Magnetic PET cover

Snap open

Totem

MATERIAL: Silver anodised aluminium

ARTICLE	POSTER	LIGHTING
UTTM001000	600 X 1700 mm	1 X 58 W
UTTM002000	700 X 1700 mm	1 X 58 W
UTTM003000	800 X 1700 mm	2 X 58 W



Snap open

Decorative Panel

Decorative

MATERIAL: Silver anodised aluminium

ARTICLE	POSTER	LIGHTING
UTTM011010	594 X 841 mm	1 X 18 W
UTTM011020	700 X 1000 mm	1 X 30 W
UTTM011040	500 X 700 mm	1 X 18 W
UTTM011030	841 X 1189 mm	2 X 36 W



Magnetic PET cover

Snap open

Pegs to hold poster





Do you need a magnetic board? Or glass board? Or a dry wipe board? Choose one among our best offerings: Magnetic Glass Board, White –on Board, Frameboards. Each offers different features to suit your needs!

BOARDS

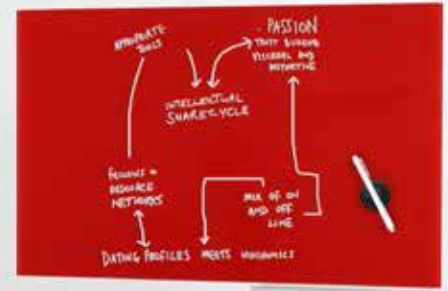

Tempered glass Magnetic Drywipe



Magnetic Glass Board

MATERIAL : Tempered glass		
ARTICLE	SIZE (x-y)	COLOUR
T00MGB0335	350 X 350 mm	White
T00MGB0135	350 X 350 mm	Black
T00MGB0435	350 X 350 mm	Red
T00MGB0345	450 X 450 mm	White
T00MGB0145	450 X 450 mm	Black
T00MGB0445	450 X 450 mm	Red
T00MGB0346	400 X 600 mm	White
T00MGB0146	400 X 600 mm	Black
T00MGB0446	400 X 600 mm	Red
T00MGB0369	600 X 900 mm	White
T00MGB0169	600 X 900 mm	Black
T00MGB0469	600 X 900 mm	Red
T00MGB0362	600 X 1200 mm	White
T00MGB0162	600 X 1200 mm	Black
T00MGB0462	600 X 1200 mm	Red



UYMGB00000
Shelves are optional accessories.



Cork Board

MATERIAL: Silver anodised aluminium	
ARTICLE	CAPACITY
UCB0N004A4	4 X A4
UCB0N006A4	6 X A4
UCB0N009A4	9 X A4



2xV hangers in each box.



M&C



Cork

Frameboard

Magnetic

MATERIAL: Silver anodised aluminium			
CORK	MAGNETIC	M&C	CAPACITY
U1CB95N144	U2CB95N144	U3CB95N144	4 X A4
U1CB95N164	U2CB95N164	U3CB95N164	6 X A4
U1CB95N194	U2CB95N194	U3CB95N194	9 X A4
U1CB95N114	U2CB95N114	U3CB95N114	12 X A4



Chalkboard Marker
UYKLM1251 - Colour Marker
UYKLM1250 - White Marker



Slim and Sleek!

The lockable poster Display case, Universal Showboard is designed to display printed poster in different options. When seen on the wall, it looks like a snap frame with slim case which is 27 mm deep, 30 mm profile and hidden lock on the side. It is suitable for public places or outdoor use under a shelter. It is easier to change the poster with hinged door and clips holding the poster.

UNIVERSAL SHOWBOARDS

27 mm thickness



Universal Poster

MATERIAL: Silver anodised aluminium

ARTICLE	POSTER SIZE	KEY
USBNU000A4	210 X 297 mm	1
USBNU000A3	297 X 420 mm	1
USBNU000A2	420 X 594 mm	1
USBNU000A1	594 X 841 mm	2
USBNU000A0	841 X 1189 mm	2
USBNU000B2	500 X 700 mm	1
USBNU000B1	700 X 1000 mm	1
USBNU00023	508 X 762 mm	1
USBNU00034	762 X 1016 mm	2



Clear plastic pegs hold the poster



Handles keep the door open



Discreet door lock!
One set of 2 key included in the pack!

27 mm thickness

Pins included



Magnets included

Magnetic



Cork

Universal Cork - Magnetic

MATERIAL: Silver anodised aluminium

CORK	MAGNETIC	CAPACITY	KEY
USBNU104A4	USBNU204A4	4 X A4	1
USBNU106A4	USBNU206A4	6 X A4	2
USBNU109A4	USBNU209A4	9 X A4	2
USBNU112A4	USBNU212A4	12 X A4	2

Size of boards for all Frameboard and Showboard models

	6A4		9A4			12A4			
4A4	A4	A4	A4	A4	A4	A4	A4	A4	A4
	A4	A4	A4	A4	A4	A4	A4	A4	A4
	A4	A4	A4	A4	A4	A4	A4	A4	A4



Suitable for outdoor use. It has 4 models; with a poster, with a cork backing, with a magnetic backing, with a cork and perforated steel backing. Can be used both in portrait & landscape positions. The cover can be opened to 90 degrees. Each unit includes mounting screw and plugs for easy wall mounting and a free set of pins & magnets. The profile width is 45 mm and the depth of the case 30 mm.

SHOWBOARDS

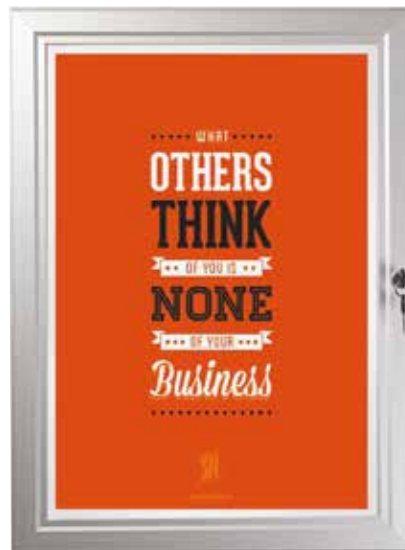

Discreet door lock!



Clear plastic pegs hold the poster

30 mm thickness

Poster

MATERIAL: Silver anodised aluminium

ARTICLE	POSTER	KEY
USBNU000A3	297 X 420 mm	1
USBNU000A2	420 X 594 mm	1
USBNU000A1	594 X 841 mm	2
USBNU000A0	841 X 1189 mm	2
USBNU000B2	500 X 700 mm	1
USBNU000B1	700 X 1000 mm	2
USBNU00023	508 X 762 mm	1
USBNU00034	762 X 1016 mm	2





Cork - Magnetic - M&C

MATERIAL: Silver anodised aluminium

CORK	MAGNETIC	M&C	CAPACITY	KEY
USBN1004A4	USBN2004A4	USBN3004A4	4 X A4	1
USBN1006A4	USBN2006A4	USBN3006A4	6 X A4	2
USBN1009A4	USBN2009A4	USBN3009A4	9 X A4	2
USBN1012A4	USBN2012A4	USBN3012A4	12 X A4	2

Felt

MATERIAL: Silver anodised aluminium

RED	BLUE	GRAY	GREEN	CAPACITY	KEY
USBN1104A4	USBN1204A4	USBN1404A4	USBN1304A4	4 X A4	1
USBN1106A4	USBN1206A4	USBN1406A4	USBN1306A4	6 X A4	2
USBN1109A4	USBN1209A4	USBN1409A4	USBN1309A4	9 X A4	2
USBN1112A4	USBN1212A4	USBN1412A4	USBN1312A4	12 X A4	2



Suitable for indoor use. It has 2 different backing models. Each unit includes a free set of pins or magnets. Single key 4xA4, double key 6xA4, 9xA4 and 12xA4 Sizes are available and can be used both in Portrait & Landscape positions. The cover can be opened to 90 degrees. Each unit includes mounting screw and plugs for easy wall mounting. The depth of the case is 35 mm. One set of 2 key included in the pack.

MATERIAL: Silver anodised aluminium

CORK	MAGNETIC	CAPACITY	KEY
USBN4004A4	USBN5004A4	4 X A4	2
USBN4006A4	USBN5006A4	6 X A4	2
USBN4009A4	USBN5009A4	9 X A4	2

OFFICE BOARDS



Suitable for outdoor use. LEDs on the top and the bottom of the profile illuminate the interior of the frame. 4x A4, 6x A4, 9x A4, 12x A4 paper capacity sizes are available. Noticeboard can be used both in portrait and landscape positions. Each unit includes a free set of pins or magnets. The profile width is 70 mm and the depth of the case 50 mm. One set of 2 key included in the pack!

NOTICEBOARDS



Cork

M&C

Magnetic

Cork - Magnetic - M&C

MATERIAL: Silver anodised aluminium			
CORK	MAGNETIC	M&C	CAPACITY
UNBN0004A4	UNBN1004A4	UNBN2004A4	4 X A4
UNBN0006A4	UNBN1006A4	UNBN2006A4	6 X A4
UNBN0009A4	UNBN1009A4	UNBN2009A4	9 X A4
UNBN0012A4	UNBN1012A4	UNBN2012A4	12 X A4



Soft edge corner
50 mm thickness



Magnetic

M&C

Cork

With LED Light

MATERIAL: Silver anodised aluminium			
CORK	MAGNETIC	M&C	CAPACITY
UNBNOL04A4	UNBN1L04A4	UNBN2L04A4	4 X A4
UNBNOL06A4	UNBN1L06A4	UNBN2L06A4	6 X A4
UNBNOL09A4	UNBN1L09A4	UNBN2L09A4	9 X A4



Cable

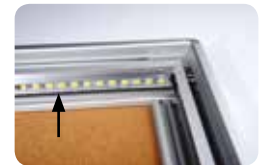

LED



With Logo

MATERIAL: Silver anodised aluminium			
CORK	MAGNETIC	CAPACITY	DESCRIPTION
UNBN0504A4	UNBN1504A4	4 X A4	Portrait
UNBN0506A4	UNBN1506A4	6 X A4	Portrait
UNBN0509A4	UNBN1509A4	9 X A4	Portrait
UNBN0512A4	UNBN1512A4	12 X A4	Portrait
UNBN0704A4	UNBN1704A4	4 X A4	Landscape
UNBN0706A4	UNBN1706A4	6 X A4	Landscape
UNBN0709A4	UNBN1709A4	9 X A4	Landscape
UNBN0712A4	UNBN1712A4	12 X A4	Landscape



Magnetic

Cork



Black rubber

Clear cover

Stays keep the door open

Logo

MAXI frame

Our Maxi Frame Range consists of mainly 5 different profile options. These profiles are designed to make 3 different models of Single Sided MAXI FRAMES, and 2 models of Double Sided MAXI FRAMES. Our standard Maxi Frames are always supplied unassembled providing connectors, hanging parts. For the double sided ceiling hanger model, the hanging wire cable system is included in each box. Please note, ceiling hanger and 4 feet options should be ordered separately.

MAXI FRAMES



Profiles of Maxi Frames

Valet Profile

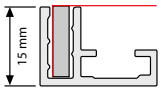

Article: UYUP014103
Valet Profile: 15x22 mm profile. The Single Sided MAXI FRAMES made up with Valet Profile are named as RIVER MAXI FRAMES. Available POSTER SIZES are: A4, A3, A2, A1, B2, B1, and 50x100cm.

Ace Profile

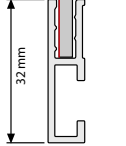

Article: UYUP014105
Ace Profile: 32x8mm profile. The Single Sided MAXI FRAMES made up with Ace Profile are named as BAY MAXI FRAMES. Available POSTER SIZES are: A4, A3, A2, A1, A0, B2, B1, B0, 50x10cm., 100x100cm., 100x150cm., and 100x200cm.

Dame Profile

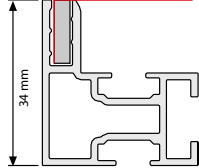

Article: UYUP014102
Dame Profile: 34x32 mm profile. The Single Sided MAXI FRAMES made up with Dame Profile are named as GULF MAXI FRAMES. Available POSTER SIZES are: 100x200cm., 100x300cm., 150x200cm., 150x300cm., 200x200cm., and 200x300cm.

Queen Profile

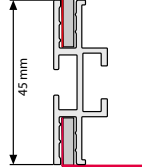

Article: UYUP014104
Queen Profile: 45x15 mm profile - Suitable for ceiling suspension. The Double Sided MAXI FRAMES made up with Queen Profile are named as LAGOON MAXI FRAMES. Available POSTER SIZES are: A4, A3, A2, A1, A0, B2, B1, B0, 50x10cm., 100x100cm., 100x150cm., and 100x200cm.

King Profile

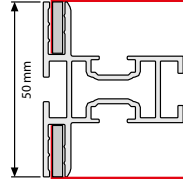

Article: UYUP014101
King Profile: 50x40 mm profile - Designed with feet for free standing. The Double Sided MAXI FRAMES made up with King Profile are named as OCEAN MAXI FRAMES. Available POSTER SIZES are: 100x140cm., 100x150cm., 100x200cm., 100x225cm., 200x150cm., 200x200cm., 200x225cm., 300x150cm., and 300x200cm., and 300x225cm.

Power LED Profile

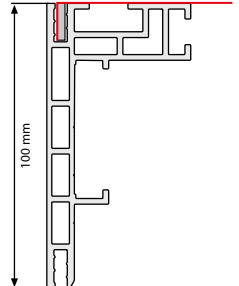

Article: UYPLPT1030
Power LED Profile.
100x50,5 mm. 3 meters.

H Profile

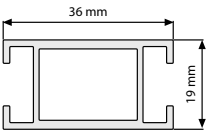

Article: UYUP014106
H Profile, 36 x19 mm, 3 meters. Suitable for Ace, Dame, Queen and King profiles.

Feets of Maxi Frame (To be used with Double Sided King Profile)



Article: UYUP412271
Circle
Ø 450 x 6mm
single packed.



Article: UYUP412272
Hoop
Ø 450 x 6mm
single packed.



Article: UYUP412273
Baseball
450 x 300 x 6mm
single packed.



Article: UYUP412274
Fillet
500 x 180 x 6mm
single packed.



Article: UYUP412275
Flat
400 x 50 x 5mm
single packed.

Application of nylon strip by sew-on process

15 mm textile fitted into maxi profile



Application of nylon strip by double sided tape

30 mm textile fitted into maxi profile





Double sided



River

MATERIAL: Silver anodised aluminium

ARTICLE	EXTERNAL (x-y)
UMFR0000A4	210 X 297 mm
UMFR0000A3	297 X 420 mm
UMFR0000A2	420 X 594 mm
UMFR0000A1	594 X 841 mm
UMFR0000B2	500 X 700 mm
UMFR0000B1	700 X 1000 mm
UMFR000510	500 X 1000 mm

Gulf

MATERIAL: Silver anodised aluminium

ARTICLE	EXTERNAL (x-y)	*H (mm)	*H (Pcs)
UMFG001020	1000 X 2000 mm	-	-
UMFG001030	1000 X 3000 mm	936 mm	1
UMFG001520	1500 X 2000 mm	-	-
UMFG001530	1500 X 3000 mm	1436 mm	1
UMFG002020	2000 X 2000 mm	-	-
UMFG002030	2000 X 3000 mm	1936 mm	2

*H: H profile

Bay

MATERIAL: Silver anodised aluminium

ARTICLE	EXTERNAL (x-y)	*H (mm)	*H (Pcs)
UMFB0000A4	210 X 297 mm	-	-
UMFB0000A3	297 X 420 mm	-	-
UMFB0000A2	420 X 594 mm	-	-
UMFB0000A1	594 X 841 mm	-	-
UMFB0000A0	841 X 1189 mm	-	-
UMFB0000B2	500 X 700 mm	-	-
UMFB0000B1	700 X 1000 mm	-	-
UMFB0000B0	1000 X 1400 mm	983 mm	1
UMFB000510	500 X 1000 mm	-	-
UMFB001010	1000 X 1000 mm	-	-
UMFB001015	1000 X 1500 mm	983 mm	1
UMFB001020	1000 X 2000 mm	983 mm	1

*H: H profile

Lagoon

MATERIAL: Silver anodised aluminium

ARTICLE	EXTERNAL (x-y)	*H (mm)	*H (Pcs)
UMFL0000A4	210 X 297 mm	-	-
UMFL0000A3	297 X 420 mm	-	-
UMFL0000A2	420 X 594 mm	-	-
UMFL0000A1	594 X 841 mm	-	-
UMFL0000A0	841 X 1189 mm	-	-
UMFL0000B2	500 X 700 mm	-	-
UMFL0000B1	700 X 1000 mm	-	-
UMFL0000B0	1000 X 1400 mm	970 mm	1
UMFL000510	500 X 1000 mm	-	-
UMFL001010	1000 X 1000 mm	-	-
UMFL001015	1000 X 1500 mm	970 mm	1
UMFL001020	1000 X 2000 mm	970 mm	1

*H: H profile



With Led

MATERIAL: Silver anodised aluminium

ARTICLE	EXTERNAL (x-y)	*H (mm)	*H (Pcs)	LIGHTING
UMLD3400A4	210 X 297 mm	-	-	2200-2400 LUX
UMLD3400A3	297 X 420 mm	-	-	2200-2400 LUX
UMLD3400A2	420 X 594 mm	-	-	2200-2400 LUX
UMLD3400A1	594 X 841 mm	-	-	2200-2400 LUX
UMLD3400A0	841 X 1189 mm	-	-	2000-2200 LUX
UMLD3400B2	500 X 700 mm	-	-	2200-2400 LUX
UMLD3400B1	700 X 1000 mm	-	-	2000-2200 LUX
UMLD3400B0	1000 X 1400 mm	936 mm	1	-
UMLD340023	508 X 762 mm	-	-	2200-2400 LUX
UMLD340034	762 X 1016 mm	-	-	2000-2200 LUX
UMLD340046	1016 X 1524 mm	952 mm	1	-

*H: H profile



Double sided



Hanging kit
UYUP460245

Ocean

MATERIAL: Silver anodised aluminium

ARTICLE	EXTERNAL (x-y)	*H (mm)	*H (Pcs)
UMFO001014	1000 X 1400 mm	-	-
UMFO001015	1000 X 1500 mm	-	-
UMFO001020	1000 X 2000 mm	-	-
UMFO001022	1000 X 2250 mm	920 mm	1
UMFO002015	2000 X 1500 mm	-	-
UMFO002020	2000 X 2000 mm	-	-
UMFO002022	2000 X 2250 mm	1920 mm	1
UMFO003015	3000 X 1500 mm	1420 mm	1
UMFO003020	3000 X 2000 mm	1920 mm	2
UMFO003022	3000 X 2250 mm	2170 mm	2

*H: H profile



Available in standard sizes as unassembled and also in lengths and parts as semi products.

For more info contact us!

POWER LED

MATERIAL: Silver anodised aluminium

ARTICLE	EXTERNAL (x-y)
UMLPTN1525	1500 X 2500 mm
UMLPTN2020	2000 X 2000 mm
UMLPTN2030	2000 X 3000 mm
UMLPTN2540	2500 X 4000 mm

MAXIMUM SIZE: 2500X6000 mm



100 mm depth



CE/UL Patent approved.

Parts



Power Maxi Led profiles 1000-5000 mm.

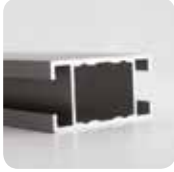

H Profiles



Red & black electrical cable 500-2500 mm.



Connectors: UYUP412270 Square Corner Connector for Power LED, included in each box.



Power Supplies 90W-160W.



Led Modules 3-S5 LED



Double sided LED Maxi Totem promotes the message with high and even illumination. Pre-treated light guided panel diffuses light even and powerfully. LED illumination saves up to 60% energy costs (compared to fluorescent technology).

MAXI FRAME TOTEM WITH LED

MATERIAL: Silver anodised aluminium

ARTICLE	POSTER	LIGHTING
UMTLN02A1	594 X 1682 mm	2100-2600 LUX

MAXIMUM SIZE: 2500X6000 mm

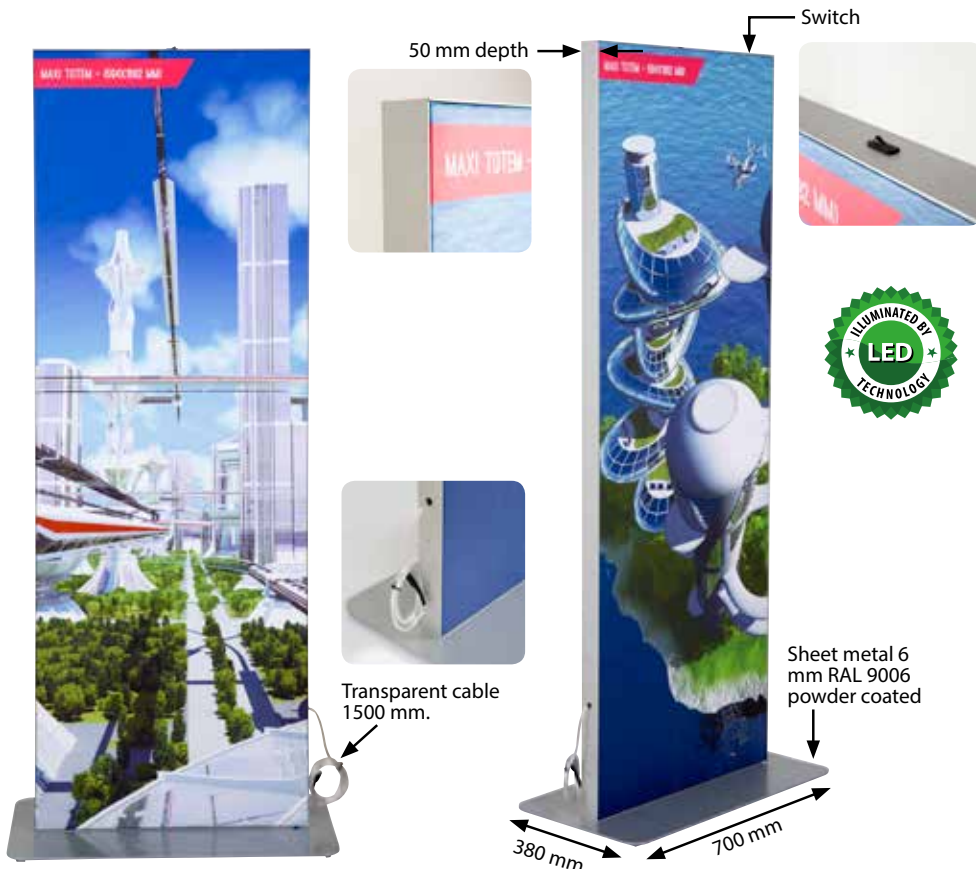

CE/UL Patent approved.

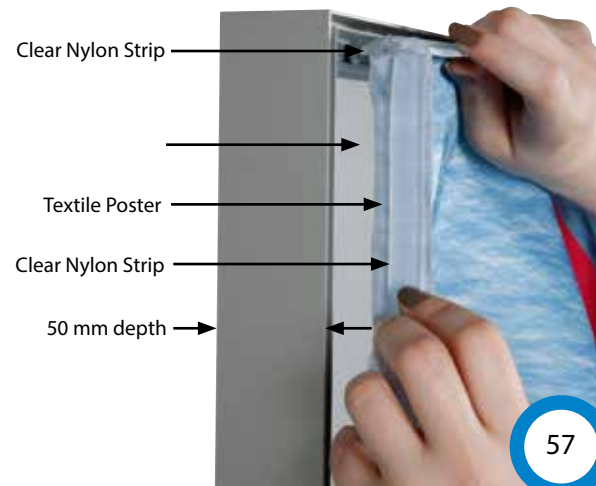



With its very slim profile, Star Maxi LED is a modern way of advertising. It is suitable for textile printed graphics. Practical poster application with clear tape provides smooth look. Complete with wall mounting accessories, Star Maxi LED is a practical advertising solution.

STAR MAXI LED



Landscape



Portrait



Portrait

← 24 mm depth

Clear Nylon Strip

Textile Poster



CE/UL approved.

Single Sided

MATERIAL: Silver anodised aluminium		
ARTICLE	EXTERNAL (x-y)	LIGHTING
UMLSTN00A4	210 X 297 mm	2400-2800 LUX
UMLSTN00A3	297 X 420 mm	2000-2200 LUX
UMLSTN00A2	420 X 594 mm	1400-1800 LUX
UMLSTN00A1	594 X 841 mm	1000-1300 LUX
UMLSTN00A0	841 X 1189 mm	800-1000 LUX
UMLSTN00B2	500 X 700 mm	1200-1500 LUX
UMLSTN00B1	700 X 1000 mm	900-1200 LUX
UMLSTN0023	508 X 762 mm	1200-1500 LUX
UMLSTN0034	762 X 1016 mm	900-1000 LUX

MAXIMUM SIZE: 850X1200 mm

Double Sided

MATERIAL: Silver anodised aluminium		
ARTICLE	EXTERNAL (x-y)	LIGHTING
UMLSCN00A4	210 X 297 mm	1200-1400 LUX
UMLSCN00A3	297 X 420 mm	1100-1300 LUX
UMLSCN00A2	420 X 594 mm	800-1100 LUX
UMLSCN00A1	594 X 841 mm	700-1100 LUX
UMLSCN00A0	841 X 1189 mm	500-900 LUX
UMLSCN00B2	500 X 700 mm	900-1200 LUX
UMLSCN00B1	700 X 1000 mm	700-1100 LUX
UMLSCN0023	508 X 762 mm	800-1200 LUX
UMLSCN0034	762 X 1016 mm	800-1000 LUX



Suitable for use in landscape and portrait positions.



Portrait

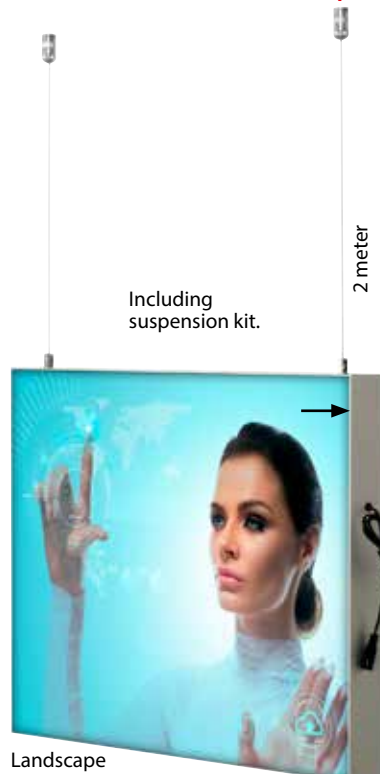

Landscape

Including suspension kit.

2 meter

50 mm depth



Clear Nylon Strip

Textile Poster

2 meter

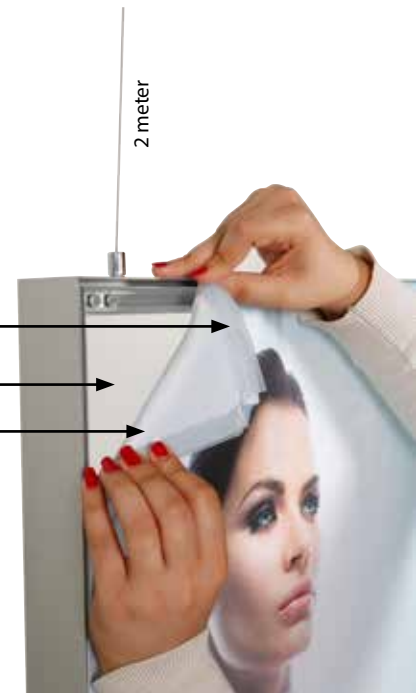

CE/UL approved.

OMNIFRAME

www.omni-frame.com



Suitable for outdoor large format prints, Omni Frame is a large format Outdoor Banner System, made from lightweight aluminium. It is ideal for use with PVC eyelet banners and mainly used for large advertising areas which need to be changed regularly such as most forecourts and retail environments. Omni Frame is suitable for flat, large banners on buildings as well as mounting stand displays for indoor and outdoor use. This banner holder is assembled quickly and easily, it is a real alternative to traditional billboards.



Wall fixing screws of Omni Frame are included in the pack which are CE certified multi-expansion long plugs. Special anti-corrosion coated screw is made of zinc coated steel and plastic sleeve made of high quality of nylon. It is confirmed for outdoor fixing on various exterior building surfaces such as concrete, solid or honeycomb brick, hollow dense or hollow light aggregate block, aerated concrete and solid stone.

Presentation Box

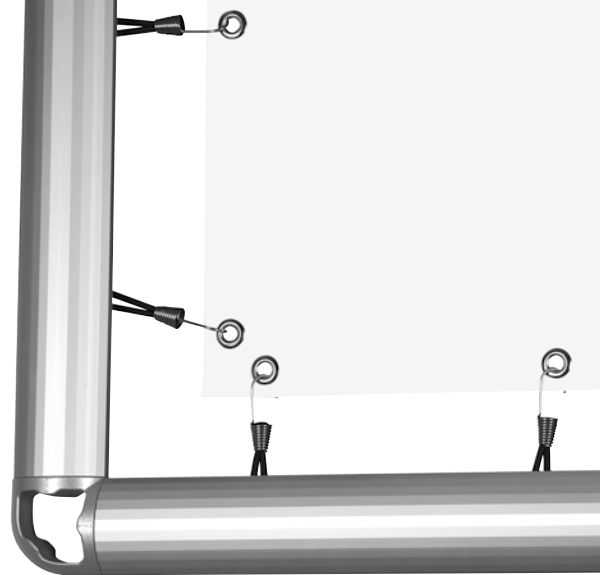

OMNI FRAME



UYPOM02000
Corner bracket
(Packed by 4 pcs),
Ral 9006



UYPOM03000
T Connector
(Packed by 2 pcs),
Ral 9006



UYPOM06000
Profile connector
(Packed by 2 pcs),
Ral 9006



UYPOM04000
Wall fixing
(Packed by 4 pcs),
including screw set.



TSH4010S01
Black bungee cord with
Stainless Steel hook
(Packed by 40 pcs)



UYPOM07000
Elastic strap
(50 meters)



Aluminium profile, Silver
anodised.



UYPOM05000
Plastic buttons
(Packed by 20 pcs)



TMC4010S00
Clamp for banner,
White (Packed by
40 pcs)



Insert and fix with screw.



Corner bracket is made of
aluminium injection and
has metallic Silver powder
coated finish.



Insert banner buttons into
the rear channel of the
profile.

4 different application options

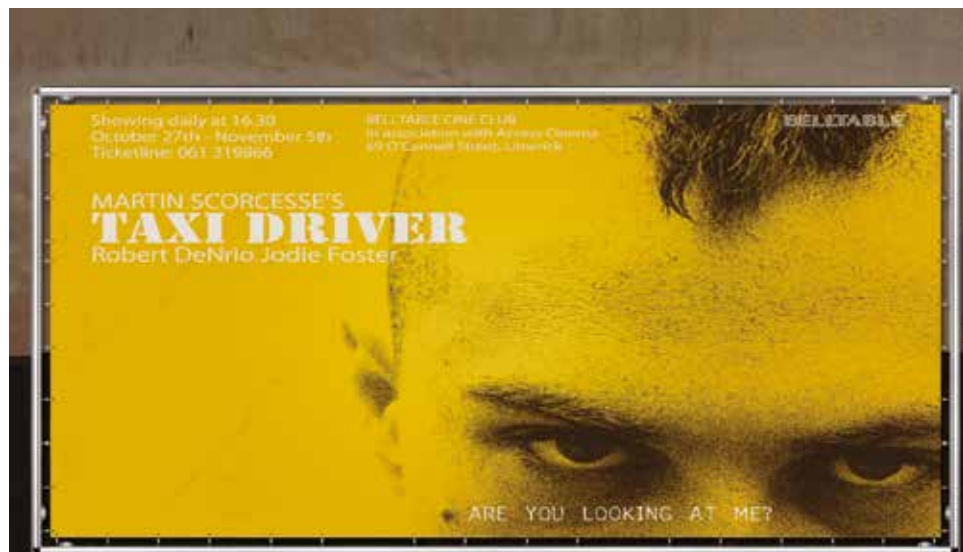
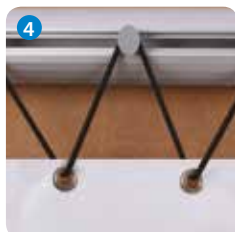
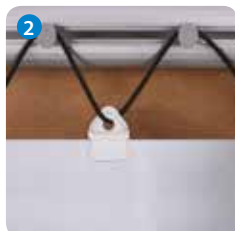



OHIM DM/084 725

SEMI PRODUCTS

ARTICLE	DESCRIPTION
UYPOM02000	Corner Bracket (Packed by 4 pcs), Ral 9006
UYPOM03000	T Connector (Packed by 2 pcs), Ral 9006
UYPOM04000	Wall Fixing (Packed by 4 pcs), including screw set
UYPOM05000	Plastic Buttons (Packed by 20 pcs)
UYPOM06000	Profile Connector (Packed by 2 pcs), Ral 9006
TMC4010S00	Clamp For Banner, White (Packed by 40 pcs)
TSH4010S01	Black Bungee Cord with Stainless Steel Hook (Packed by 40 pcs)
UYPOM07000	Elastic Strap (50 meters)

PROFILE

ARTICLE	LENGHT
UYPOM01011	1100 mm
UYPOM01016	1600 mm
UYPOM01021	2100 mm
UYPOM01026	2600 mm
UYPOM01031	3100 mm
UYPOM01036	3600 mm
UYPOM01041	4100 mm
UYPOM01046	4600 mm
UYPOM01051	5100 mm

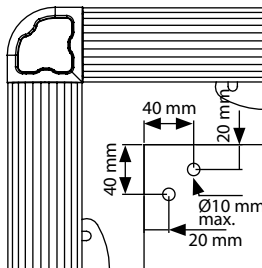

FRAME: Silver anodised aluminium

ARTICLE	EXTERNAL (x-y)	POSTER SIZE
UOMN001010	1221 X 1221 mm	1000 X 1000 mm
UOMN001015	1221 X 1721 mm	1000 X 1500 mm
UOMN001515	1721 X 1721 mm	1500 X 1500 mm
UOMN001520	1721 X 2221 mm	1500 X 2000 mm

The first eyelet should be placed on the corners 40mm from the edges of poster used for Omni Frame. Please see below basic drawing. The other eyelets can be applied spacing 15-30cm from the first eyelet depending on the environment to be used.



Constructed aluminium, Omni A Board is a double sided, heavy outdoor banner system. It is ideal for use with PVC eyelet banners. Omni A Board is used for large advertising areas that the banner needs to be changed regularly or carried to different places. It is a great accompaniment for outdoor events, marquee and race. Omni Frame withstands approximately 42-50 kph wind.

OMNI A BOARD



1,2 kg Each feet.

OHIM DM/084 725

Perfect outdoor use.
 •Ease of transport, quick & easy installation.
 •Flexible outdoor display with excellent durability.



MATERIAL: Silver anodised aluminium

ARTICLE	EXTERNAL (x-y)	POSTER SIZE
UAOMN01510	1221 X 1721 mm	1000 X 1500 mm
UAOMN02510	1221 X 2721 mm	1000 X 2500 mm
UAOMN03012	1471 X 3221 mm	1250 X 3000 mm

OMNI A BOARD FEET / HINGE

ARTICLE	DESCRIPTION
UYPOM09000	Feet for Omni Aboard, 4pcs per pack
UYPOM10000	Hinge for Omni Aboard, 2pcs per pack



Cary bag

BAG: Black

ARTICLE	SIZE
UYPOM00010	265 X 2650 X 205 mm
UYPOM00020	265 X 1630 X 205 mm



It is an economical and easy-to-use product. You just can put in your PVC foam poster with 5 to 10mm thickness and adjust the nut of fixing from the bottom part of the aluminum box. It can be used in all indoor areas such as schools, seminars, restaurant chains, showrooms, exhibition areas, malls and everywhere else.

EASY SWAP



Fixing nut

MATERIAL : Silver anodised aluminium

ARTICLE	POSTER
UMS0100300	300 mm
UMS0100600	600 mm
UMS0100800	800 mm
UMS0100900	900 mm
UMS0101000	1000 mm
UMS0101200	1200 mm
UMS0101500	1500 mm



The system is mainly based on screwing the 2 pieces of the bases to each other to stand the poster still. Adjustable thickness of poster. The maximum height of poster is 150 cm. Base is double sided printable. Suitable for all indoor areas such as schools, seminars, restaurant chains, showrooms, exhibition areas, malls and everywhere else.

POSTER TRAP

MATERIAL : Silver, powder coated in RAL 9006

ARTICLE	POSTER
UMS0000300	300 mm
UMS0000600	600 mm
UMS0000800	800 mm
UMS0000900	900 mm
UMS0001000	1000 mm



Quick banners provide practical and easy use of banners without any tool assembly. It is portable to fit in a small size of textile carry bag. You can choose one of single or double sided Quick Banners.

QUICK BANNERS

Single Sided

MATERIAL : Silver anodised aluminium

ARTICLE	POSTER
UQB0T00N72	700 X 2000 mm
UQB0T00N82	800 X 2000 mm
UQB0T00N92	900 X 2000 mm
UQB0T00N12	1000 X 2000 mm

Double Sided

MATERIAL : Silver anodised aluminium

ARTICLE	POSTER
UQB0C00N72	700 X 2000 mm
UQB0C00N82	800 X 2000 mm
UQB0C00N92	900 X 2000 mm
UQB0C00N12	1000 X 2000 mm

Patent TR 2005 01772



Gray carry bag



Single sided

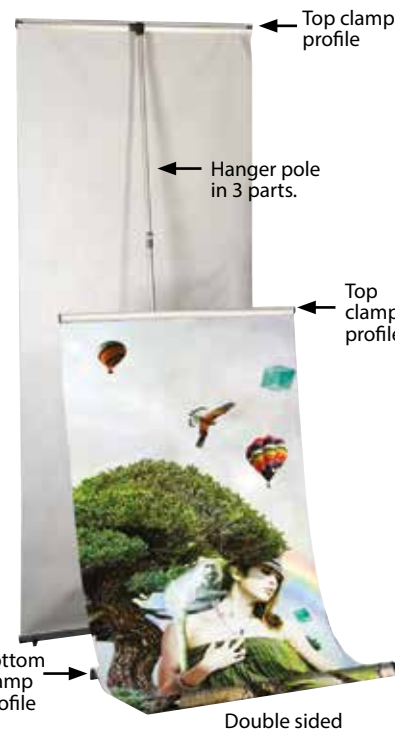

Double sided



poster clamp system no tape applied!



Single sided hanger



Double sided hanger



Newage Quick Banner display offers competitive solutions. Suitable to hold banners in thickness 50 micron / 500 micron. New Age Quick Banner is a flexible and mobile set that can be carried to conventions or exhibitions within its bag.

NEWAGE QUICK BANNER

MATERIAL : Silver anodised aluminium

ARTICLE	POSTER
UQBETOON62	600 X 2000 mm
UQBETOON72	700 X 2000 mm
UQBETOON82	800 X 2000 mm
UQBETOON92	900 X 2000 mm
UQBETOON12	1000 X 2000 mm

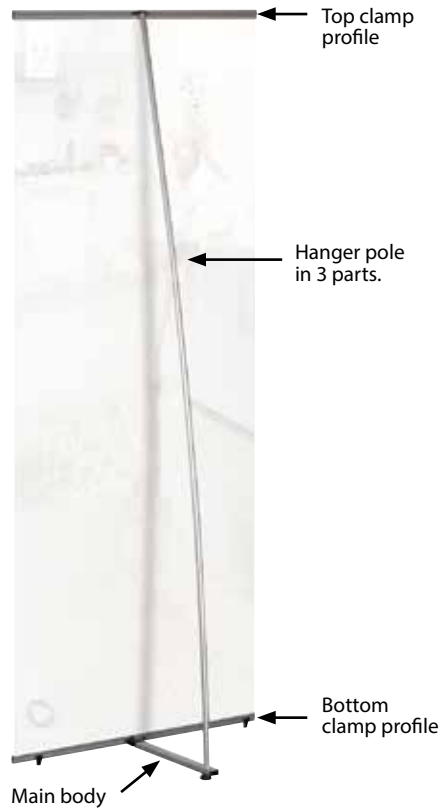

Poster clamp system!

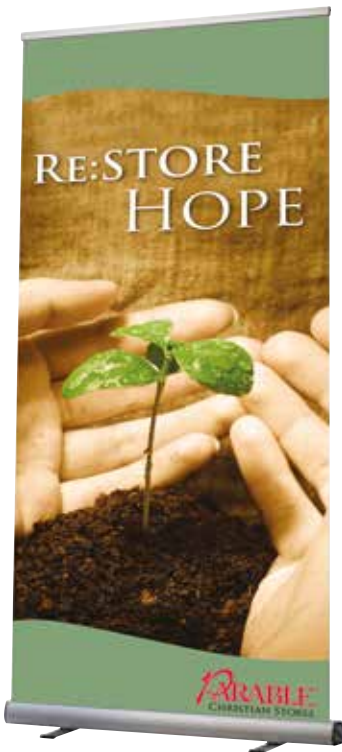

OHIM DM 084 128

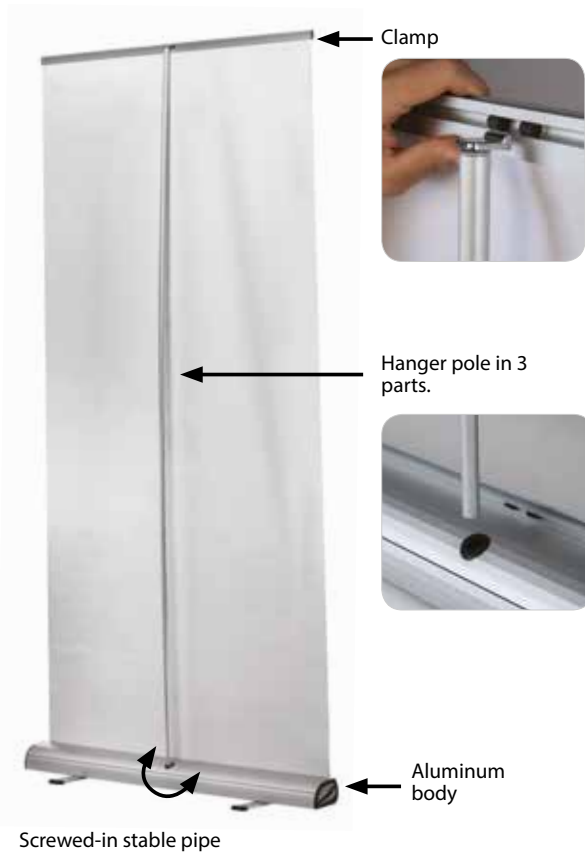

Retractable poster displays system, Optima Roll banner is made of aluminum with the finest craftsmanship and got stylish edge finishes. It is easy to operate and requires no tools to set up. Retractable system provides protection during transportation. The base houses the poster and feet. Removable retractable system is ideal for applications where the message changes regularly.

OPTIMA BANNERS

MATERIAL : Silver anodised aluminium

ARTICLE	POSTER	DESCRIPTION
URB001N082	800 X 2000 mm	with bag
URB001N092	900 X 2000 mm	with bag



Transport bag

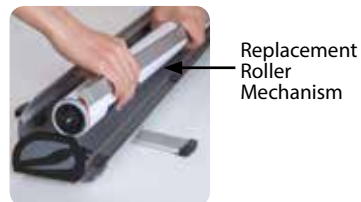

Replacement Roller Mechanism

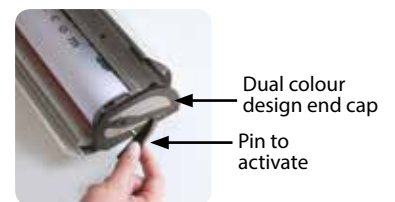

Dual colour design end cap
Pin to activate



Smart Roll Banner; With the latest revision on Smart Roll Banner, M&T concentrated on both design and outlook features of the product&functionality. Pipe fixation addition, improved end caps provide a more stable product and the new revised design gives a more elegant look to the product. The aluminum body is silver anodised, stands at min 1000 mm, max 2300 mm height, has a unique telescopic pipe.

SMART ROLL BANNERS

Single Sided

MATERIAL : Silver anodised aluminium

ARTICLE	POSTER
URBST00N82	800 mm
URBST00N92	900 mm
URBST00N12	1000 mm

Double Sided

MATERIAL : Silver anodised aluminium

ARTICLE	POSTER
URBSC00N82	800 mm
URBSC00N92	900 mm
URBSC00N12	1000 mm

Patent Pending
PCT/TR 2005/000044, EP 05801071
DE 20 2004 021 229 OHIM DM 084 128

Single sided



Double sided



Adjustable height telescopic pipe min 1000 mm max. 2300 mm



Stable pipe fixation



Stable pipe fixation



Transport bag

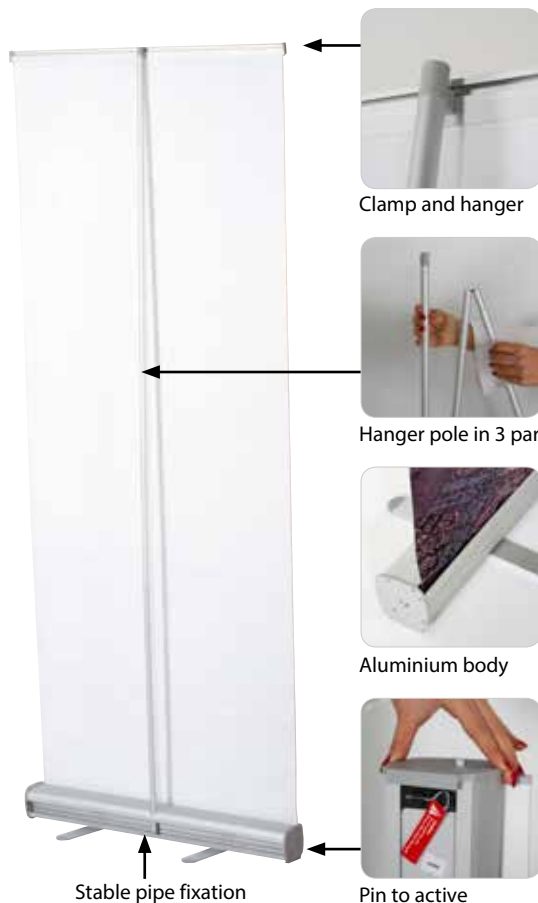

The rolling cylinder comes ready at the point available to place in the art work. After the placement of the art work, the cylinder runs immediately once the pin on one end is off. The rolling cylinder can be set up and stretched in the required tightness.

ECO ROLLER

MATERIAL : Silver anodised aluminium

ARTICLE	POSTER
URBETO0N82	800 X 2000m
URBETO0N12	1000 X 2000 mm

Bag for Eco Roll Banner





An ideal brochure stand that allows an indoor use of different models. The fixing grooves on both sides of the central pole hold single-sided or double-sided frames and shelves separately or collectively at the same time. The frames are recommended for use in 30 mm profiles in both Portrait or Landscape position.

FREE STANDING LEAFLET DISPLAY

Snap Frame

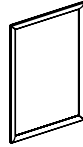

SNAP FRAME: 30 mm 45° - 30 mm round		
MITRED ARTICLE	ROUND ARTICLE	POSTER
UFSL005000	UFSL011000	420 X 594 mm
UFSL004000	UFSL010000	594 X 841 mm
UFSL006000	UFSL012000	500 X 700 mm
UFSL008000	UFSL014000	700 X 1000 mm

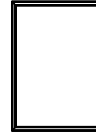

Slide-in Frame

MATERIAL : Silver anodised aluminium	
ARTICLE	POSTER
UFSL130300	210 X 297 mm
UFSL130200	297 X 420 mm
UFSL130100	420 X 594 mm
UFSL130500	508 X 762 mm
UFSL130400	500 X 700 mm

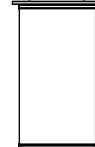

Banner

MATERIAL : Silver anodised aluminium	
ARTICLE	POSTER
UFSL110000	400 mm
UFSL110100	500 mm
UFSL110200	600 mm
UFSL110300	700 mm

Shelf

8 mm MDF SHELF			
ARTICLE	SIZE	DESCRIPTION	WEIGHT CAPACITY
UFSL002500	Ø250 mm	Model 1 Circle	max. 1 kg
UFSL002510	250 X 250 mm	Model 1 Square	max. 1 kg
UFSL002550	Ø250 mm	Model 2 Circle	max. 5 kg
UFSL002560	250 X 250 mm	Model 2 Square	max. 5 kg

Model 1

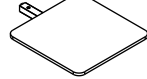

Model 2

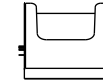

MATERIAL: Clear Acrylic		
ARTICLE	DESCRIPTION	SIZE
UFSL140000	Acrylic Shelf	A4
UFSL140100	Acrylic Shelf	A5
UFSL140200	Acrylic Shelf	1/3 A4



MATERIAL: Clear Acrylic		
ARTICLE	DESCRIPTION	SIZE
UFSL120000	Acrylic Shelf	A4

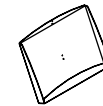

STEEL & ACRYLIC SHELF	
ARTICLE	CAPACITY
UFSL002000	2 X A4 steel shelf
UFSL003000	2 X A4 acrylic shelf

Main Body Profile Type

2 Channel



Powder coated in RAL 9006

MAINBODY WITH 2 CHANNEL

ARTICLE	DESCRIPTION	SIZE
UFSL001000	Main body pole	1920 mm
	Main body base	Ø 450 mm

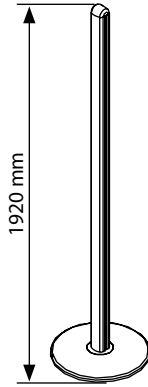

Some possible variations using 2 channel profile

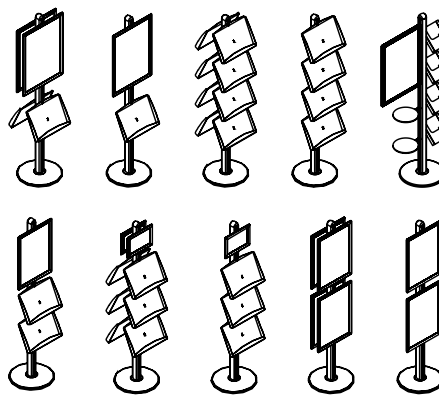

4 Channel



Powder coated in RAL 9006

MAINBODY WITH 4 CHANNEL

ARTICLE	DESCRIPTION	SIZE
UFSL001100	Main body pole	1920 mm
	Main body base	450 X 450 mm

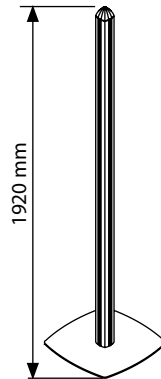

Some possible variations using 4 channel profile

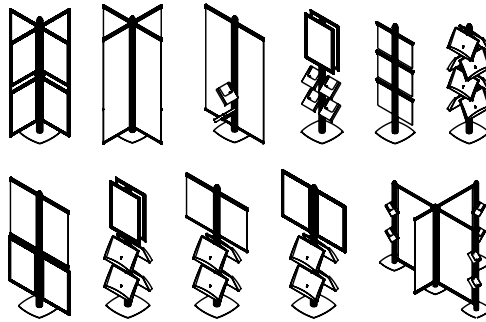

Novel 4 Channel



Powder coated in RAL 9006

MAINBODY WITH NOVEL 4 CHANNEL

ARTICLE	DESCRIPTION	SIZE
UFSL001200	Main body pole	1920 mm
	Main body base	450 X 450 mm

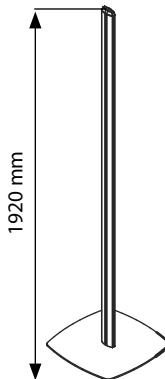

Some possible variations using Novel 4 channel profile

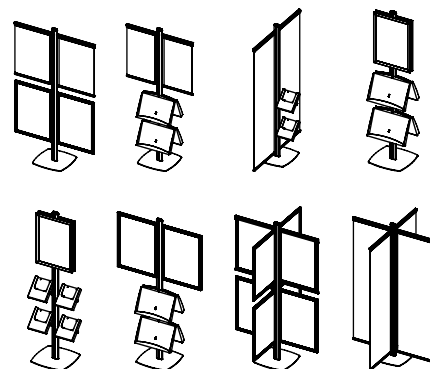

Header



MATERIAL : Opaque acrylic		
ARTICLE	DESCRIPTION	SIZE
UFSL120200	Header	450 X 160 mm
UFSL120100	Header	350 X 160 mm



Leaflet Display

2 Channel



4 Channel

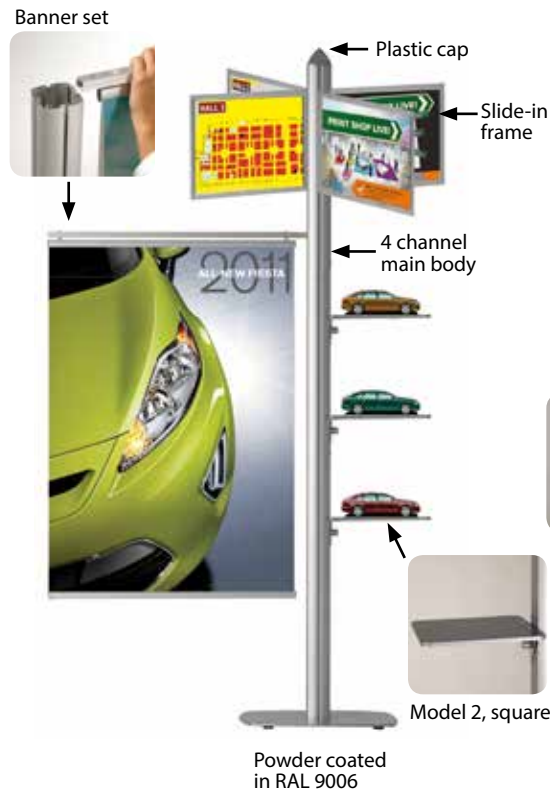

Novel 4 Channel

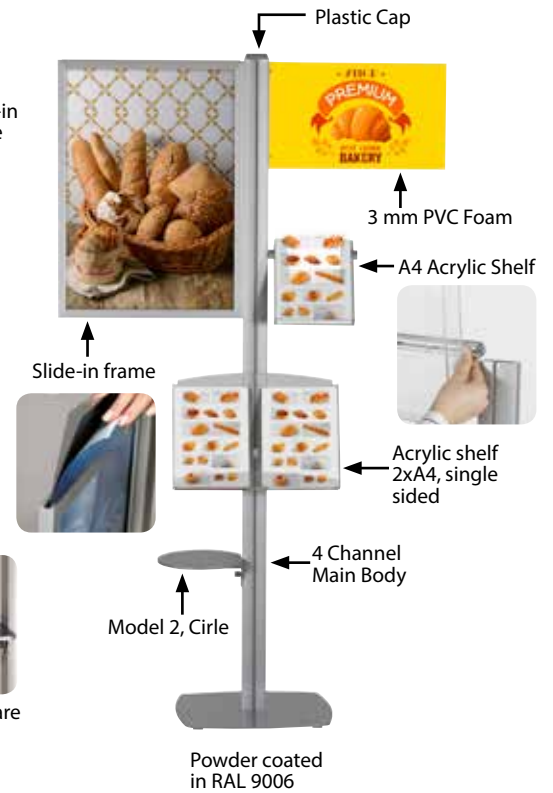

Leaflet Dispensers



Leaflet With Side Shelves



Convex Box



MATERIAL : Silver anodised aluminium	
ARTICLE	POSTER
UTTM014100	420 X 594 mm
UTTM014000	594 X 841 mm
UTTM014200	500 X 700 mm
UTTM014300	508 X 762 mm



Easy to build, stylish brochure holder. Designed to hold various brochures fulfilling your personal wishes and needs. The connector structure offers you space for individual adjustment of the shelves. To complete a product, main body and required quantities of shelves need to be ordered separately.

COCTAIL BROCHURE SETS

MATERIAL : Silver anodised aluminium & acrylic shelf

ARTICLE	DESCRIPTION	SIZE
UCBSG00024	Main body	2 X A4
UCBSG00034	Main body	3 X A4
UMSDA008A4	Acrylic Shelf & Adapter	8 X A4
UMSD008000	Acrylic Shelf	A4
UYUP490000	Adapter	



Coctail Brochure Set for Wall

MATERIAL: Clear Acrylic

ARTICLE	POSTER	DESCRIPTION
UCBSW200A4	210 X 297 mm	A4 Portrait
UCBSW200A5	148 X 210 mm	A5 Portrait
UCBSW30A43	105 X 210 mm	1/3 A4 Portrait



1 - Pole

3 - Pole

4 - Pole

1 Pole - 3 Pole - 4 Pole

MATERIAL : Silver anodised aluminium & acrylic shelf

1 POLE	3 POLE	4 POLE	DESCRIPTION	SIZE
UMBSG205A4	UMBSG305A4	UMBSG405A4	Main body	5A4
UMBSG205A5	UMBSG305A5	UMBSG405A5	Main body	5A5
UMBSG20523	UMBSG30523	UMBSG40523	Main body	5X2A4/3
UMSDA005A4	UMSDA005A4	UMSDA005A4	Acrylic Shelf & Adapter	A4
UMSDA012A4	UMSDA012A4	UMSDA012A4	Acrylic Shelf & Adapter	A4
UMSDA000A5	UMSDA000A5	UMSDA000A5	Acrylic Shelf & Adapter	A5
UMSDA00A43	UMSDA00A43	UMSDA00A43	Acrylic Shelf & Adapter	1/3 A4
UMSDA02A43	UMSDA02A43	UMSDA02A43	Acrylic Shelf & Adapter	2X1/3 A4



1 - Pole Black

3 - Pole Chrome

On Wheels - Rotating

MATERIAL : Silver anodised aluminium & acrylic shelf

1 POLE	3 POLE	4 POLE ROTATING	DESCRIPTION	SIZE
UMBSG2T5A4	UMBSG3T5A4	UMBSG4D5A4	Silver main body	5A4
UMBBG2T5A4	UMBBG3T5A4	UMBBG4D5A4	Black main body	5A4
UMSDA005A4	UMSDA005A4	UMSDA005A4	Acrylic Shelf & Adapter	A4
UMSDA012A4	UMSDA012A4	UMSDA012A4	Acrylic Shelf & Adapter	A4
UMSDA000A5	UMSDA000A5	UMSDA000A5	Acrylic Shelf & Adapter	A5
UMSDA00A43	UMSDA00A43	UMSDA00A43	Acrylic Shelf & Adapter	1/3 A4
UMSDA02A43	UMSDA02A43	UMSDA02A43	Acrylic Shelf & Adapter	2X1/3 A4



Multiside Brochure sets are developed to provide multiple variations at low costs. Based on 1, 3 or 4 poles, robust aluminum body with height of 1,5 meters, various number of shelves can be fitted to make a brochure set meeting your exact needs. To complete a product, main body and required quantities of shelves need to be ordered separately. Brochure holders are quickly and easily inserted.

MULTISIDE BROCHURE SETS



Color options :
Silver & Black.



4 Pole Rotating



Multiple-pocket leaflet dispenser, Prime Wall Unit ties up the busy environment. It is also important tool for use in any office, lobby retail store or bank. The main body is produced by polystyrene material. This thermoformed body in aesthetic shape provides easy access to the leaflets or brochures. Clear PET-G pockets provide a full view of the flyers or brochures stored in.

PRIME WALL UNIT

MATERIAL : PET -G & Clear Acrylic		
ARTICLE	CAPACITY	DESCRIPTION
UPW0G003A4	3 X A4	Gray
UPW0B003A4	3 X A4	Black
UPW0W003A4	3 X A4	White
UPW0G004A5	4 X A5	Gray
UPW0B004A5	4 X A5	Black
UPW0W004A5	4 X A5	White
UPW0G04A43	4 X 1/3 A4	Gray
UPW0B04A43	4 X 1/3 A4	Black
UPW0W04A43	4 X 1/3 A4	White



3x A4 White

3x A4 Gray

4x A5 White

4x 1/3 A4 Black



3 X A4
3 X (8.5"X11")



4 X A5
4 X (6.5"X8")



4 X A4/3
4 X (4"X9")

Flexible scratch resistant PC body



Made of polycarbonate, Portable Leaflet Dispensers provide both flexibility and saving from the space in the offices, shops and hotels and more. Transparent pockets offer a complete view of the brochure or fliers.

PORTABLE LEAFLET DISPENSERS

MATERIAL : PC body	
ARTICLE	CAPACITY
UPBW0030A4	3 X A4 - 8.5" X 11"
UPBW0040A5	4 X A5 - 6.5" X 8.5"
UPBW004A43	4XA4/3 - 4" X 9"



Double sided

Single sided

for Wall

MATERIAL : Silver anodised aluminium & acrylic shelf	
ARTICLE	CAPACITY
UBSSC10N24	16 X A4 double sided
UBSST10N24	8 X A4 single sided
UBSSC10N34	24 X A4 double sided
UBSST10N34	12 X A4 single sided
UBSSC10N44	32 X A4 double sided
UBSST10N44	16 X A4 single sided
UBSSD10N24	8 X A4 for wall



A brochure holder designed to keep minimum 6 / maximum 32 brochures at the same time in stores, galleries and banks. When used with 4 wheels it is free and mobile. Single or double sided options are available. Transparent shelves do not block the brochures or magazines.

BROCHURE SETS



Tower Brochures System is a new way of displaying multiple brochures. Design it the way you like and offer plenty of style. You can choose among 6 options of the stand and right shelf size or magnetic pocket. You can also brand it with your logo.

TOWER BROCHURE STANDS

SHELF : Steel			
ARTICLE	POSTER	DESCRIPTION	COLOUR
UYPTS00A4	210 X 297 mm	A4	Gray
UYPTSB00A4	210 X 297 mm	A4	Black
UYPTS00A5	148 X 210 mm	A5	Gray
UYPTSB00A5	148 X 210 mm	A5	Black
UYPTS00A6	105 X 148 mm	A6	Gray
UYPTSB00A6	105 X 148 mm	A6	Black
UYPTS00A43	99 X 210 mm	1/3 A4	Gray
UYPTSB00A43	99 X 210 mm	1/3 A4	Black
UYPTS0015			Gray
UYPTSB0015			Black

Color options :
Silver & Black.

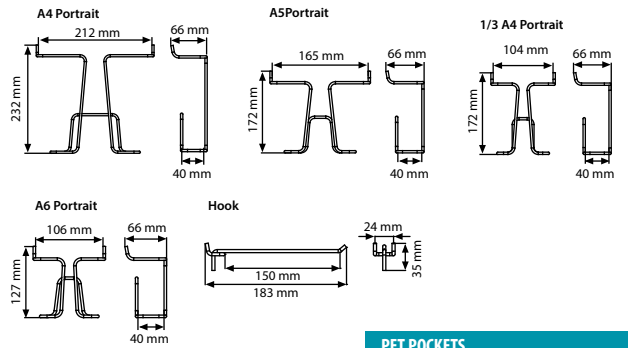

PET POCKETS

ARTICLE	PAPER SIZE	DESCRIPTION
TAB0590304	210 X 297 mm	Red
TAB0590301	210 X 297 mm	Black
TAB0590309	210 X 297 mm	Grey

Pockets in 3 colours
Each colour boxed
in 10 pcs.
Please don't forget
to order.



Curved

MATERIAL : Steel

ARTICLE	COLOUR
USTCU0G265	Gray
USTCU0B265	Black
USTCU0G460	Gray
USTCU0B460	Black

Don't forget to
order brochure
holders



For Wall

MATERIAL : Steel

ARTICLE	COLOUR
USTFWOG265	Gray
USTFWOB265	Black
USTFWOG460	Gray
USTFWOB460	Black



Use with magnets



Twin

MATERIAL : Steel

ARTICLE	COLOUR
USTTWOG265	Gray
USTTWOB265	Black
USTTWOG460	Gray
USTTWOB460	Black

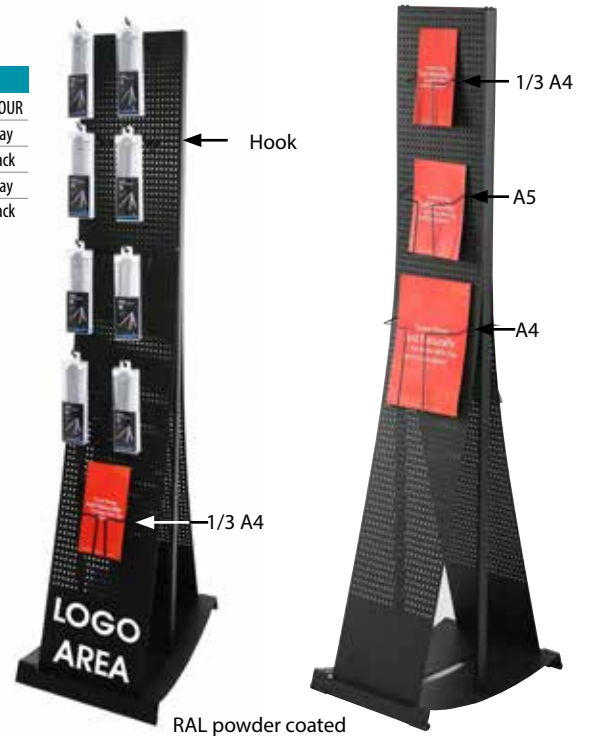

Double Sided

MATERIAL : Steel

ARTICLE	COLOUR
USTDSOG265	Gray
USTDSOB265	Black
USTDSOG460	Gray
USTDSOB460	Black

Basic

MATERIAL : Steel	
ARTICLE	COLOUR
USTBS0G265	Gray
USTBS0B265	Black
USTBS0G460	Gray
USTBS0B460	Black

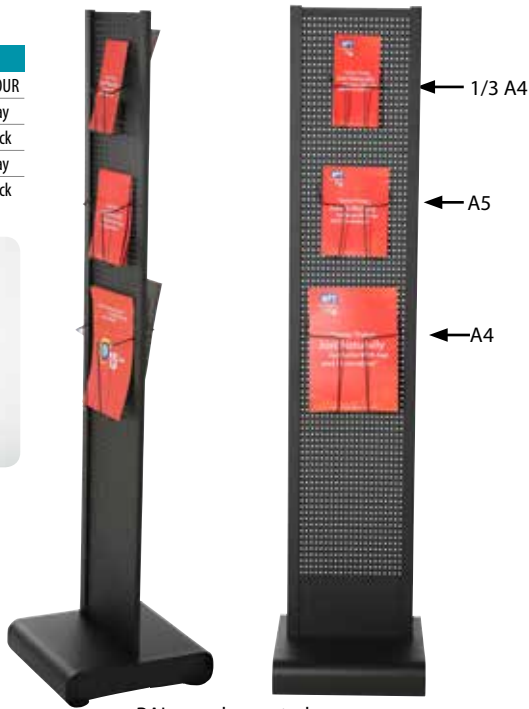

RAL powder coated

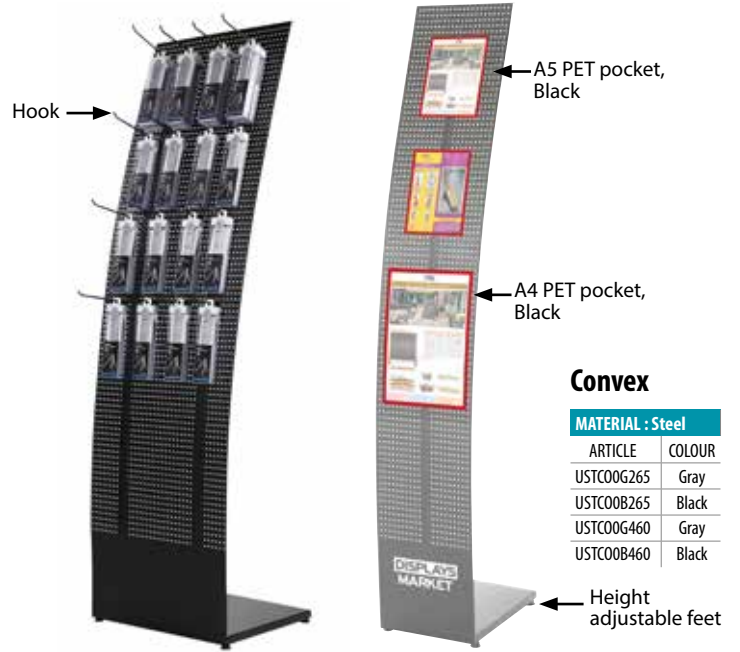

RAL powder coated

Convex

MATERIAL : Steel	
ARTICLE	COLOUR
USTC00G265	Gray
USTC00B265	Black
USTC00G460	Gray
USTC00B460	Black

Height adjustable feet

New selection of literature display including injected counter top with a robust aluminum body. 3x A4 capacity and 6x 1/3 A4 capacity standards are available.

PILLAR BROCHURE STAND

MATERIAL : Silver anodised aluminium & acrylic

ARTICLE	SIZE
UPBS3000A4	A4
UPBS300A43	1/3 A4



Available in A4 Size in Portrait & Landscape positions. Decorative Brochure Stand Plus is delivered with easy to change header on top

DECORATIVE BROCHURE STAND & PLUS

MATERIAL : Silver anodised aluminium & acrylic

ARTICLE	DESCRIPTION
UDBS20Y0A4	A4 Landscape with Logo
UDBS20D0A4	A4 Portrait with Logo
UDBS10Y0A4	A4 Landscape
UDBS10D0A4	A4 Portrait



A4 Landscape A4 Portrait with logo



MATERIAL : Silver and Black anodised aluminium & acrylic

SILVER	BLACK	SIZE
URDB0002A4	URDBB002A4	2 X A4
URDB0003A4	URDBB003A4	3 X A4

Poster
Clear acrylic

Rapid Brochure set has a stylish look and eye-catching shelves. A4 shelves are made of frosted acrylic and easily placed on the aluminum poles. Boxed in flat with unassembled shelves, it guarantees easy and safe transportation. Display your leaflets in retail stores or merchandising settings

RAPID BROCHURE SET



Perfect for displaying A4 or 8,5"x11" literatures to your customers and potential clients. You have clear or aluminium stand as well as single or double side options. Choose one of our offerings to fit your request!

ZICK-ZACKS

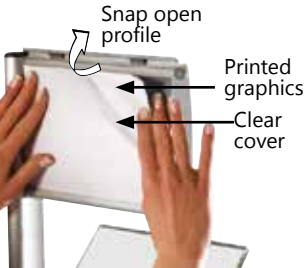

Zick-Zack

MATERIAL: Silver anodised aluminium
SHELF: Acrylic

ARTICLE	MODEL	CAPACITY
UZZTAC1001	Single leg	6 X A4
UZZTAC1002	Single leg with header	6 X A4
UZZCAC1002	Double Leg	6 X A4

10 mm acrylic shelf width 225 mm



Single Leg Zick-Zack

225 mm
148 mm

10 mm acrylic shelf width 225 mm



Double Leg Zick-Zack with Header

218 mm
165 mm
Logo header with snap open profile

10 mm acrylic shelf width 225 mm



Single Leg Zick-Zack with Header



Lock the shelf

Zick-Zack Lite

MATERIAL: Silver anodised aluminium
SHELF: Acrylic

ARTICLE	MODEL	CAPACITY
UZZTLT0001	Single leg	6 X A4
UZZTLT0002	Single leg with header	6 X A4



Textile transport bag

Newage Portable

MATERIAL: Clear & Grey RAL 9006

ARTICLE	SIZE	DESCRIPTION
UZZEPS0100	5 X A4	
UZZEPS0000	5 X A4	with bag
UYUP072400	5 X A4	without bag

Bag

8 mm acrylic shelf width 225 mm



Single Leg Zick-Zack Lite

218 mm
165 mm
Logo header with snap open profile

8 mm acrylic shelf width 225 mm



Single Leg Zick-Zack Lite with Header



An elegant & classic clear stand to display an A4 size paper message on top, altering a pocket for literature packs in again an A4 size. Simple to change the message, eye-catching level of height. Suitable for use in galleries & showrooms accessible to the public.

MONOBLOCK



A4 Size pocket



MATERIAL: Acrylic

ARTICLE	CAPACITY
UMNB001000	A4



A unique design to hang TV's. Very portable for room-to-room transport. Has a universal bracket that is designed to fit all VESA universal bracket. Ideal to use in fairs, meeting rooms, halls and many other businesses. No visual clutter: the cables can be hidden into the rear column.

TV STAND



Top exit for cords



Middle exit for cords



Bottom exit for cords

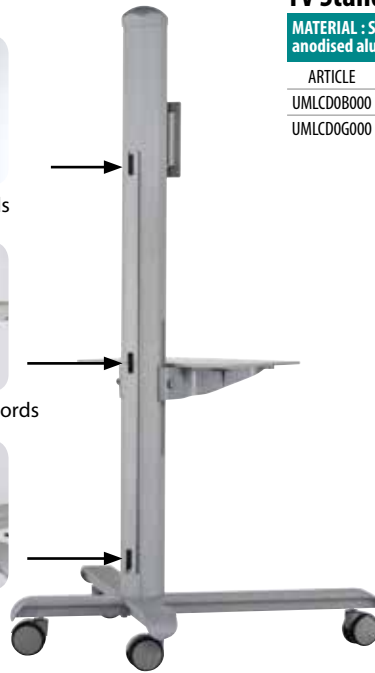

TV Stand

MATERIAL : Silver & Black anodised aluminium

ARTICLE	DESCRIPTION
UMLCDOB000	Black
UMLCDOG000	Gray



Adjustable TV display



Flexible shelf position

Locking wheels

Semi Circle

MATERIAL : ABS Plastic

ARTICLE	DESCRIPTION
TGRIA30301	Black
TGRIA30309	Silver

360° Rotating



Silver



Silver

Adjustable angle



Black



We offer large choice of tablet or smart phone holders. They are portable to carry for meetings and presentations. Well designed to care for your valuables, all holders have soft edges.

TABLET HOLDERS

Black Tripod

MATERIAL : ABS & Aluminium

ARTICLE	DESCRIPTION
TGRIA30201	Black



Soft touch

Adjustable angle

Adjustable height



Gray Tripod

MATERIAL : ABS & Aluminium

ARTICLE	DESCRIPTION
TLCPO22009	Silver



Adjustable angle



Pocket

MATERIAL : ABS & Aluminium

ARTICLE	DESCRIPTION
TGRID10301	Black



Hook

MATERIAL : ABS Plastic

ARTICLE	DESCRIPTION
TGRID10201	Black

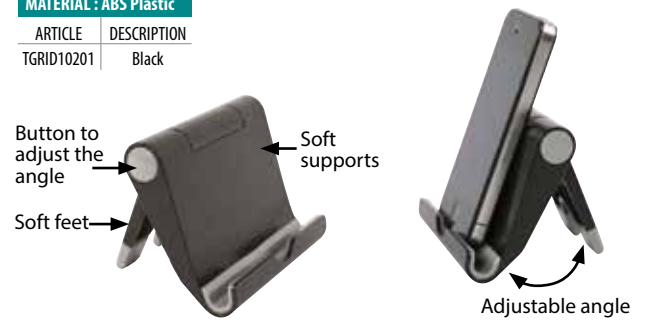

Turred

MATERIAL : ABS Plastic

ARTICLE	DESCRIPTION
TLCPO08009	Silver



Peak

MATERIAL : ABS Plastic

ARTICLE	DESCRIPTION
TLCPO36003	White-Pink
TLCPO37009	Silver



Pyramid

MATERIAL : ABS Plastic

ARTICLE	DESCRIPTION
TFRIA30303	White





Whatever brand your tablet is, you can find a floor standing stand model to fit in. Each accommodates different size of tablets. In order to secure the tablet or stand, you can use cable lock kit with a combination lock. Do not forget to order 3m long USB cables to fit your tablet!

TABLET STANDS

Don't forget to order USB cable.



TSTDCI450B
Cable for
iPhone 4&5.



TSTDCIP40B
Cable for
iPhone 4.



TSTDCIP50B
Cable for
iPhone 5.



TSTDCV80B
Cable V8 for
Samsung.



TZZZ998701
Cable lock kit for
iPad 2100mm.

Red Spider Floor

MATERIAL : ABS & Aluminium

ARTICLE	DESCRIPTION
TGRIF80604	Red

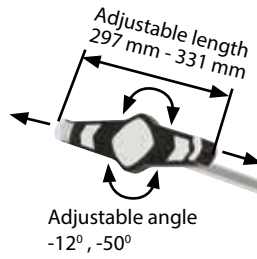

One product,
two positions
(landscape & portrait)

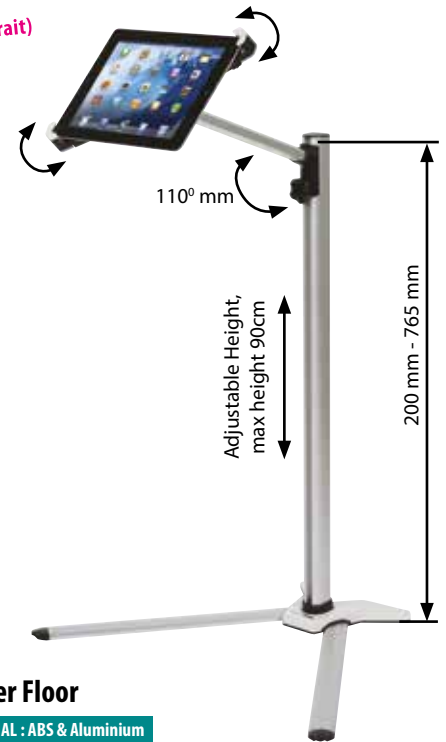

Spider Floor

MATERIAL : ABS & Aluminium

ARTICLE	DESCRIPTION
TLCP707009	Silver

Boomerang Floor

One product,
two positions
(landscape & portrait)

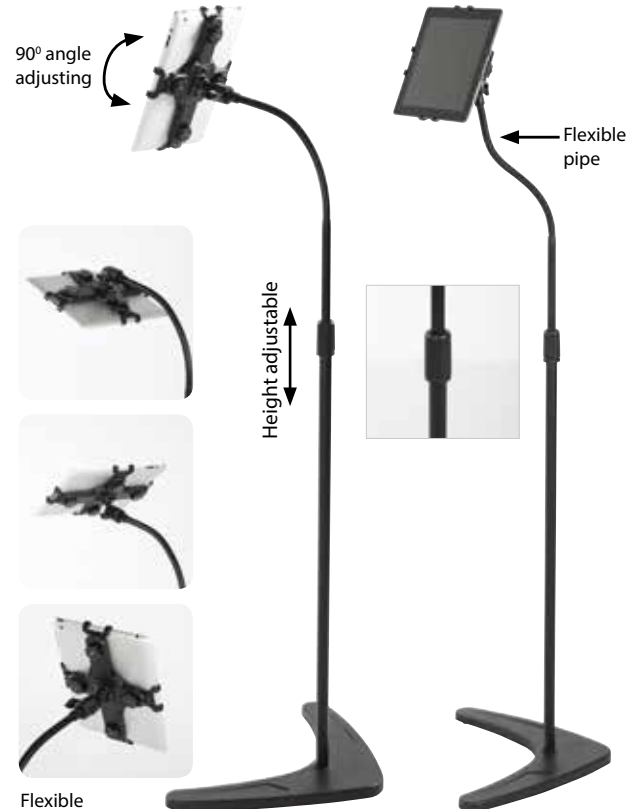

Boomerang Floor

MATERIAL : ABS Plastic & Steel Base

ARTICLE	DESCRIPTION
TGRIF40101	Red



Smart Solutions for Technological Devices!
 Universal Tablet Kiosks are offered with a large range and suitable for iPad1, 2, 3, 4, Air, Samsung Galaxy and most 9.7"-10.1" tablets. The tablet holder can be rotated to display landscape portrait positions and tablet is secured with a lockable case to reduce the risk of theft. Suitable for retail purposes, trade shows and conventions as well as car galleries, furniture stores.

UNIVERSAL TABLET KIOSK



UYPPD000
 Lightning to 30-pin adapter. Packed by 10 pcs. You can use all type of Kiosk for iPad 4 too.



TZZZ998701
 Cable lock kit for iPad 2100mm.

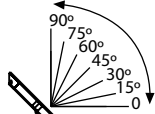

"90° adjustable angle"



One product, two positions (landscape & portrait)

Adjustable height

Adjustable height

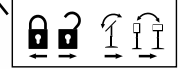

Landscape & portrait lock



Adjustable height lock

Flexible Tablet Kiosk

MATERIAL : Silver anodised aluminium

ARTICLE	HEIGHT MAX.	HEIGHT MIN.
UUTFON0B00	1095 mm	785 mm

Novel Tablet Kiosk

MATERIAL : Silver & Black anodised aluminium

ARTICLE	DESCRIPTION
UPDNON0W00	White
UPDNON0B00	Black



One product, two positions (landscape & portrait)

Lock

Landscape & portrait lock



in & out adjustable base



TZZZ998701
 Cable lock kit for iPad 2100mm.

Universal Novel Tablet Kiosk for Wall & Freestanding

MATERIAL : Silver anodised aluminium

ARTICLE	DESCRIPTION
UUTWON1B00	for Wall / White
UUTWOB1B00	for Wall / Black
UUTNFN1B00	for Freestanding / White
UUTNFB1B00	for Freestanding / Black



One product, two positions (landscape&portrait)



Curved Tablet Kiosk

MATERIAL : Black anodised aluminium

ARTICLE	DESCRIPTION
UUTC0B1B00	Black



One product, two positions (landscape&portrait)



Lock
Landscape & portrait lock
Lock



Desktop Tablet Kiosk

MATERIAL : Steel & acrylic

ARTICLE	DESCRIPTION
UUTMOB1B00	Black



One product, two positions (landscape&portrait)





Panset exhibition system is a portable & user friendly assembled Panel construction. The durable framework of Panset can be positioned between 0-360°. The framework of the construction can be easily unassembled to permit a quick change of the Panel inside.

PANSET

MATERIAL : Silver anodised aluminium
Panel: Plastech PVC Foam

ARTICLE	PANEL	HEADER
UPNS000035	700 X 1000 mm	300 X 700 mm
UPNS000034	700 X 1000 mm	300 X 700 mm
UPNS000033	700 X 1000 mm	300 X 700 mm



3x5 / 3x4 / 3x3 Panset

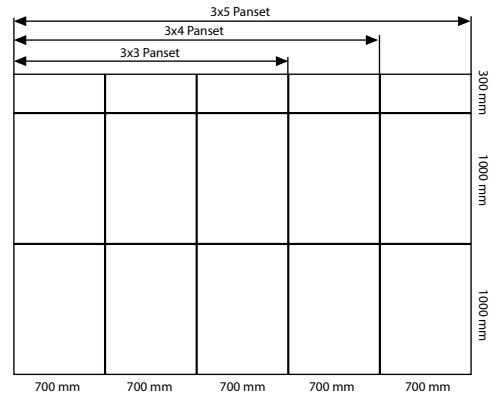

Bag / UYUP076100
Panset black carry bag
main body for all size.
Don't forget to order.



Bag / UYUP075100
Panset black carry bag for
logo for all size. Don't
forget to order.



Pop-up counter



Light / UYUP367130
Don't forget to order

POP-UP WITH MAGNETIC

ARTICLE	Model
UPPC220033	Pop Up 3x3 (with Bag)
UPPC220034	Pop Up 3x4 (with Bag)
UPPC230033	Pop Up 3x3 (with Bag& Lighting)
UPPC230034	Pop Up 3x4 (with Bag& Lighting)

POP-UP WITH MAGNETIC : Aluminium

ARTICLE	MODEL	PVC PANEL				HOLDER				MAGNETIC BAR	MAGNETIC STRIPES
		CENTRAL	QUANTITY	SIDE	QUANTITY	CENTRAL	QUANTITY	SIDE	QUANTITY		
UPPC200033	3 X 3	680 X 2265 mm	3	650 X 2265 mm	2	680 X 56 X 2 mm	6	650 X 56 X 0,8 mm	4	1 set 18 pcs	30 m (1 rulo)
UPPC200034	3 X 4	680 X 2265 mm	4	650 X 2265 mm	2	680 X 56 X 2 mm	8	650 X 56 X 0,8 mm	4	1 set 21 pcs	30 m (1 rulo)

3x4 Printing Panel Sizes

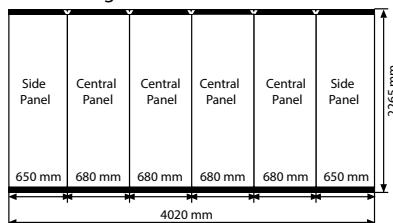

3x3 Printing Panel Sizes

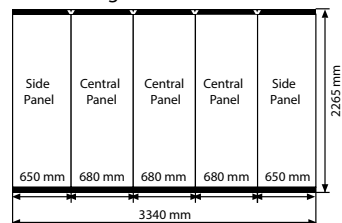

Pop-up stands are still the most popular standard display for large graphic displays. They are easy to transport, light weight, simple pop-ups and packable into a roto-molded plastic carry bag for transportation. Pop-up displays have a variety of sizes 3x3, 3x4. Panels are fitted to create a round display. Lights are available when requested.

POP-UP MAGNETIC



Transport bag / UPP0110000



Crown Truss System is developed for the display and exhibition industry for modular and practical advertisement purpose. It is made of strong and durable materials; aluminium, steel and composite. At the same time it is a lightweight and foldable truss construction. Very easy to assemble, disassemble, pack and carry.

CROWN TRUSS



Color options :
White & Black.



CROWN
PREMIUM DISPLAYS

Crown Truss Parts

MODULE 150X150 MM

BLACK	WHITE	SIZE
UCT15BM030	UCT15WM030	300 mm
UCT15BM060	UCT15WM060	600 mm
UCT15BM090	UCT15WM090	900 mm
UCT15BM120	UCT15WM120	1200 mm
UCT15BM150	UCT15WM150	1500 mm
UCT15BM180	UCT15WM180	1800 mm
UCT15BM210	UCT15WM210	2100 mm

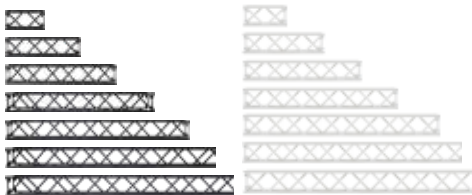

FOR BANNER HANGING

ARTICLE	SIZE
UCT15BP030	300 mm
UCT15BP060	600 mm
UCT15BP090	900 mm
UCT15BP120	1200 mm
UCT15BP150	1500 mm
UCT15BP180	1800 mm
UCT15BP210	2100 mm

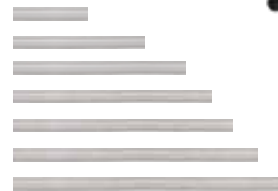

REGULAR BASE

BLACK	WHITE	SIZE
UCT15BF220	UCT15WF220	190 X 190 mm



SIDE BASE

BLACK	WHITE	SIZE
UCT15BF245	UCT15WF245	190 X 400 mm



MIDDLE BASE

BLACK	WHITE	SIZE
UCT15BF260	UCT15WF245	190 X 600 mm



CORNER BLOCK

BLACK	WHITE
UCT15BK00	UCT15WK00



CONNECTOR CROSS

BLACK	WHITE
UCT15BAE00	UCT15WAE00



CLIP-ON FITTING

BLACK	WHITE
UCT15BBT00	UCT15WBT00



CLIPS FOR BANNER

BLACK	WHITE	SIZE
UCT15BA00	UCT15WAA00	Top clips
UCT15BAU00	UCT15WAA00	Bottom clips



SHELFS

BLACK	WHITE	SIZE
UCT15BR062	UCT15WR062	600 mm
UCT15BR092	UCT15WR092	900 mm
UCT15BR122	UCT15WR122	1200 mm
UCT15BR152	UCT15WR152	1500 mm
UCT15BR440	UCT15WR440	L Shape
UCT15BRT00	UCT15WRT00	Shelf holder



ACRYLIC HOLDER

BLACK	WHITE	SIZE
UCT15BB0A4	UCT15WB0A4	A4
UCT15BB0A5	UCT15WB0A5	A5
UCT15BBA43	UCT15WBA43	1/3 A4



SPOTS

ARTICLE	DESCRIPTION
UCT15BLT10	Spotlight 150 W
UCT15BLT10	Spotlight fitting



Build your own display in 3D!

Crown Truss Models

Model 768 / UCT15BM768

Truss L-Shape 3 x 3

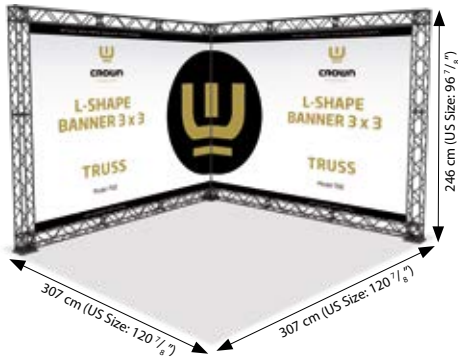

Model 770 / UCT15BM770

Truss L-Shape 4 x 4

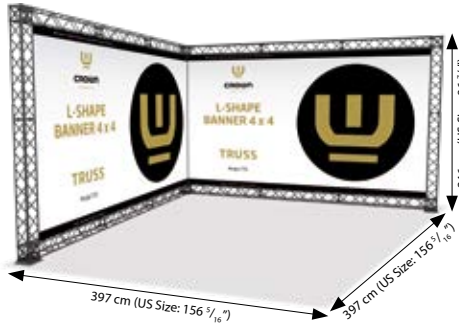

Model 772 / UCT15BM772

Truss L-Shape 5 x 5

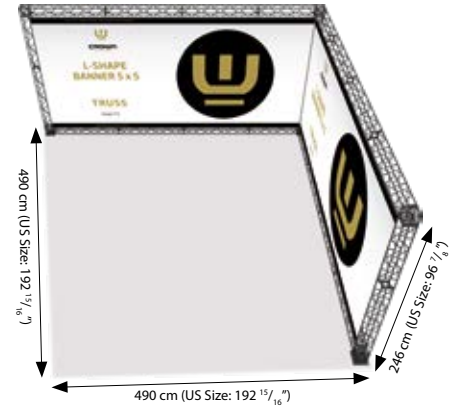

Model 774 / UCT15BM774

Truss L-Shape 4 x 6

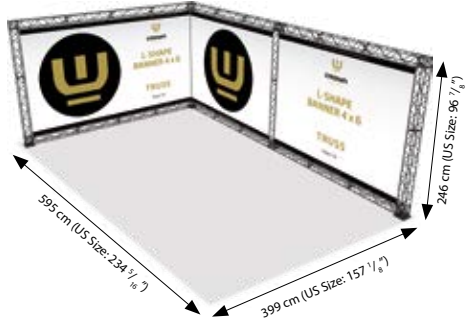

Model 769 / UCT15BM769

Truss U-Shape 3 x 3

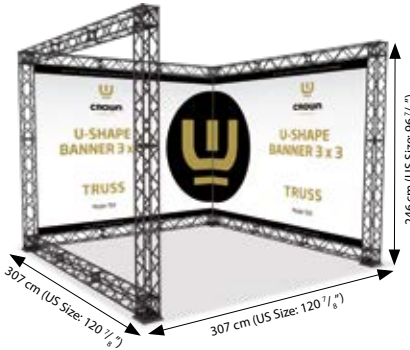

Model 771 / UCT15BM771

Truss U-Shape 4 x 4

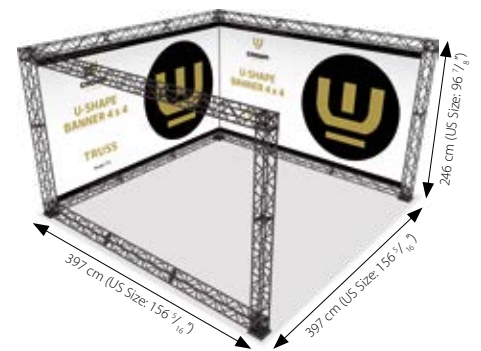

Model 773 / UCT15BM773

Truss U-Shape 5 x 5

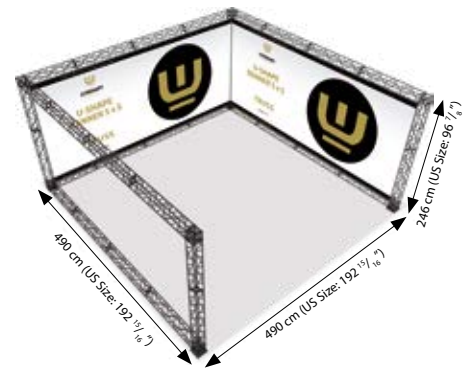

Model 775 / UCT15BM775

Truss U-Shape 4 x 6

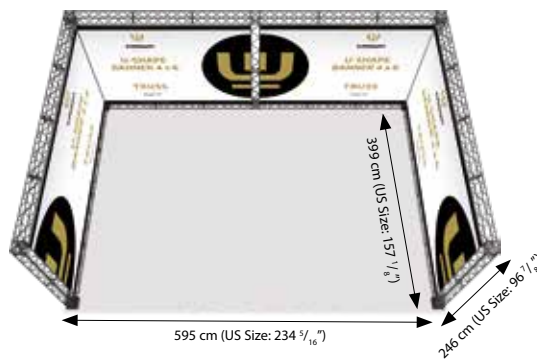

Crown Truss Counter

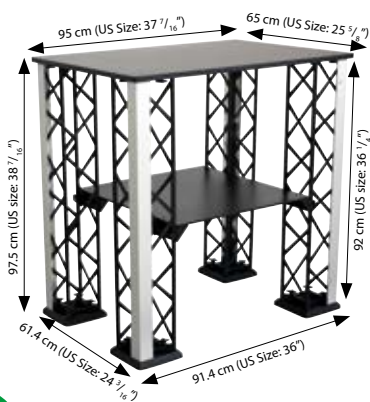

CROWN TRUSS COUNTER

BLACK	WHITE	MODEL
UCT15BSP00	UCT15WSP00	With shelf
UCT15BS010	UCT15WS010	Without shelf



Panset counters are ideal products with a light & compact structure. They can be carried to different locations and re-used many times. It is easy and quick to install. Different models meet your needs in the most convenient manner. These counters are lightweight and when unassembled can even fit into trunk of a car.

PANSET COUNTER



Transport bag / UYUP074100

Hexagonal

MATERIAL : Silver anodised aluminium
PANEL: Plastech PVC Foam

ARTICLE	MODEL	PANEL	QUANTITY
UPSM001000	Hexagonal	878 X 659 mm	1
		878 X 311 mm	4
UPSM007000	Wood Hexagonal	878 X 659 mm	1
		878 X 311 mm	4

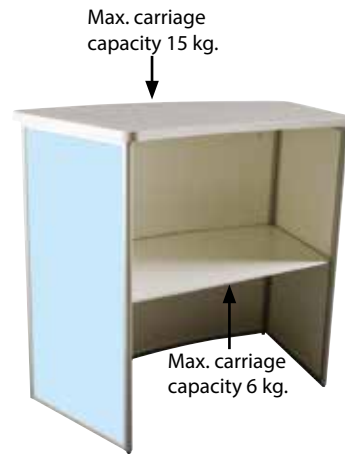
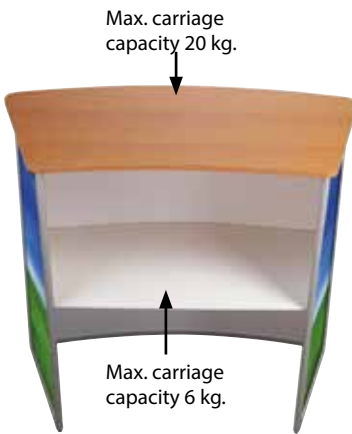

Convex

MATERIAL : Silver anodised aluminium
PANEL: Plastech PVC Foam

ARTICLE	MODEL	PANEL	QUANTITY
UPSM002000	Convex	878 X 980 mm	1
		878 X 430 mm	2
UPSM008000	Wood Convex	878 X 980 mm	1
		878 X 430 mm	2



Transport bag / UYUP074100

Midsize Convex

MATERIAL : Silver anodised aluminium
PANEL: Plastech PVC Foam

ARTICLE	PANEL	QUANTITY
UPSM052000	718 X 878 mm	1
	335 X 878 mm	2



Transport bag / UYUP074100

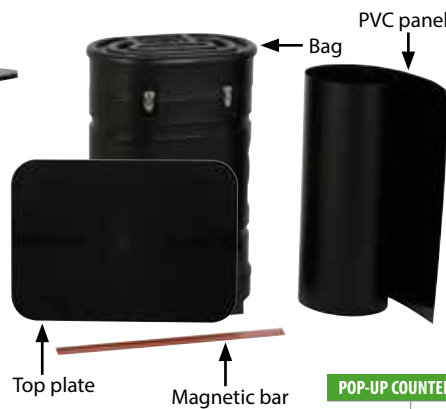

The pop-up counter offers an easy low-budget solution that can be carried to various locations and even re-used after many events. The counter can pop up in a second with no tools required

POP-UP COUNTER

POP-UP COUNTER BAG: 0,50 mm, black PVC panel

ARTICLE	PVC PANEL	COPY SIZE	TOP PLATE	MAGNETIC BAR
UPP0115020	1620 X 800 mm	1550 X 755 mm	700 X 500 mm	1 Pcs



Lightweight, portable and cost-effective display counters, now available in various styles. All flat pack designs for easy transport. Do not forget to order accessories such as carry bag, shelves, header, etc.

PROMOSTANDS



CARRY BAG

ARTICLE	DESCRIPTION
UYPOTS1050	for Seed Promostand
UYPOTS2050	for Seed Promostand with pole system
UYPOTS3050	for Circle Promostand
UYUP072200	for Large Promostand
UYUP072300	for Petit Promostatnd



UYPOTS0030
Velcro Roll with double sided tape 18 meters.



UYPOTSP03G
Grey felt only for Seed Promostand with Pole System incl. Velcro set for 900 mm.

A4 Acrylic Shelf
UFSL140000

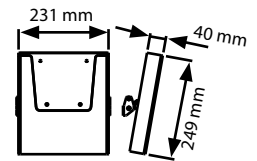

MDF Shelf Circle
UFSL002500

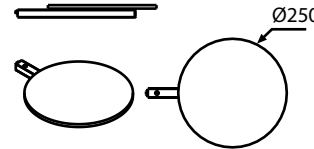

MDF Shelf Square
UFSL002510

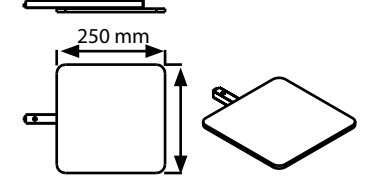

Rectangular

MATERIAL: Plastic

ARTICLE	DESCRIPTION	PANEL SIZE	PRINTING SIZE
UTSD000909	w/out bag,w/out felt,w/out shelf	1849 X 892 mm	1815 X 865 mm
UTSD020909	with header,w/out bag,w/out felt,w/out shelf	1849 X 892 mm	1815 X 865 mm
UTSD010912	w/out bag,w/out felt,w/out shelf	1849 X 892 mm	1815 X 865 mm
UYPOTS0010	Inner shelf only,white	850 X 450 mm	
UYPOTSD020	Inner shelf only for header ,white	850 X 450 mm	
UYPOTSD03G	Grey felt only incl.Velcro.Grey felt only incl.Velcro.	1870 X 865 mm	1870 X 865 mm



Circle

MATERIAL: Plastic

ARTICLE	DESCRIPTION	PANEL SIZE	PRINTING SIZE
UTSR000609	w/out bag,w/out felt,w/out shelf	1238 X 892 mm	1204 X 865 mm
UTSR020609	with header,w/out bag,w/out felt,w/out shelf	1238 X 892 mm	1204 X 865 mm
UTSR010612	w/out bag,w/out felt,w/out shelf	1238 X 892 mm	1204 X 865 mm
UYPOTSR010	Inner shelf only,white	550 X 415 mm	
UYPOTSR020	Inner shelf only for header ,white	550 X 415 mm	
UYPOTSR03G	Grey felt only incl.Velcro.	1253 X 865 mm	1253 X 865 mm



Bean

MATERIAL: Plastic

ARTICLE	DESCRIPTION	PANEL SIZE	PRINTING SIZE
UTSB000909	w/out bag,w/out felt,w/out shelf	1557 X 892 mm	1523 X 865 mm
UTSB020909	with header,w/out bag,w/out felt,w/out shelf	1557 X 892 mm	1523 X 865 mm
UTSB010912	w/out bag,w/out felt,w/out shelf	1557 X 892 mm	1523 X 865 mm
UYPOTSB010	Inner shelf only,white	855 X 370 mm	
UYPOTSB020	Inner shelf only for header ,white	855 X 370 mm	
UYPOTSB03G	Grey felt only incl.Velcro.	1575 X 865 mm	1575 X 865 mm



Seed

MATERIAL: Plastic			
ARTICLE	DESCRIPTION	PANEL SIZE	PRINTING SIZE
UTSC00909	w/out bag,w/out felt,w/out shelf	1530 X 892 mm	1496 X 865 mm
UTSC020909	with header,w/out bag,w/out felt,w/out shelf	1530 X 892 mm	1496 X 865 mm
UTSC010912	w/out bag,w/out felt,w/out shelf	1530 X 892 mm	1496 X 865 mm
UYPOTSC010	Inner shelf only,white	850 X 444 mm	
UYPOTSC020	Inner shelf only for header ,white	850 X 444 mm	
UYPOTSC03G	Grey felt only incl.Velcro.	1560 X 865 mm	1560 X 865 mm
UTSC030909	Pole system,w/out bag or felt or shelf or header	1557 X 892 mm	1523 X 865 mm
UYPOTSC040	Header only for pole system	500 X 350 mm	500 X 350 mm
UYPOTSP010	Inner shelf only for pole system,White	873 X 444 mm	
UYPOTSP03G	Grey felt only for pole system incl.Velcro	1583 X 865 mm	1583 X 865 mm

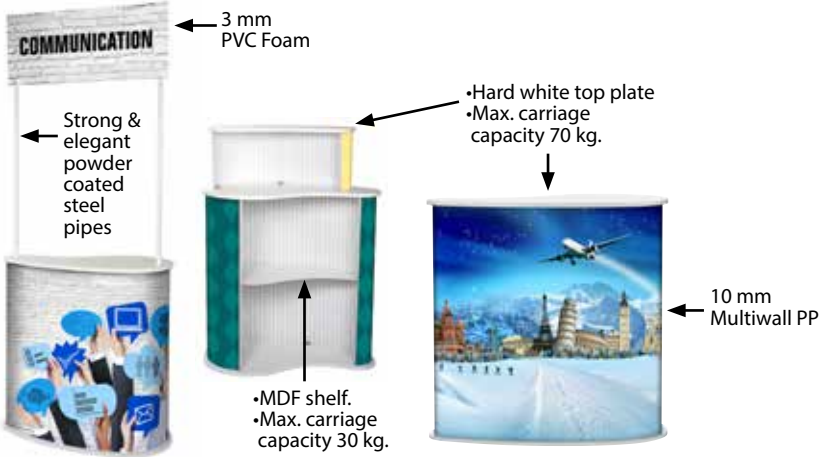

Variations & Seed Promostand with Pole System

Make up your stand to fit your own wishes!



Mix and match your own stand!

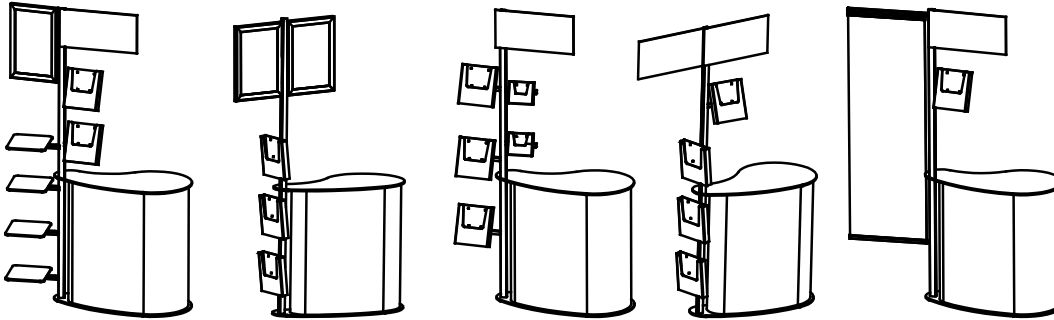

Don't forget to order separately!

- Inner shelf
- Grey felt
- Carry bag
- Header
- Ladder
- Circle & square shelves
- Leaflet holders
- Slide-in frames
- Banner holder

Large

MATERIAL : Plastic		
ARTICLE	DESCRIPTION	PANEL SIZE
UTS00N5000	Without bag	2004 X 900 mm
UTS00N5100	With bag	2004 X 900 mm
UYUP072200	Bag	

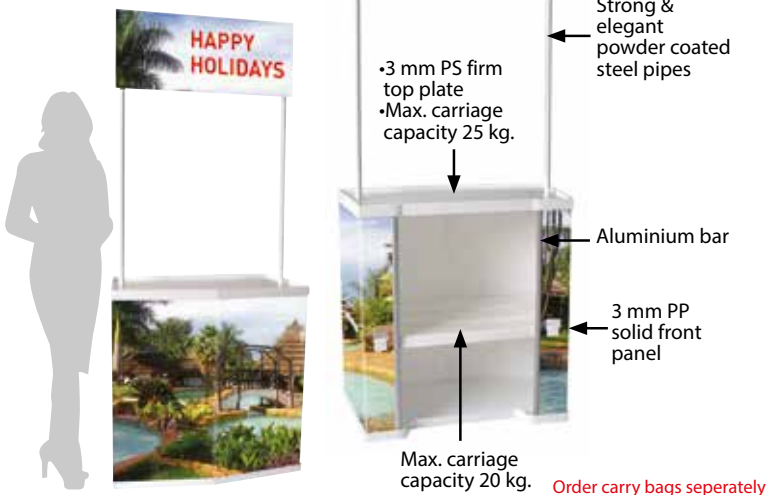

Petit

MATERIAL : Plastic		
ARTICLE	DESCRIPTION	PANEL SIZE
UTS00N3000	Without bag	1596 X 900 mm
UTS00N3100	With bag	1596 X 900 mm
UYUP072300	Bag	





Highly resistant transparent document holders are suitable for the display of all types of documents such as catalogues, brochures, cards for every need, etc... These high quality clear leaflet dispensers can be branded with logo on your request. Various sizes as well as single or multiple tier are offered for your needs.

LEAFLET DISPENSERS

Leaflet Dispenser

MATERIAL : Clear		
ARTICLE	POSTER	DESCRIPTION
UMSD001005	210 X 297 mm	A4 Portrait
UMSD001004	148 X 210 mm	A5 Portrait
UMSD001003	100 X 210 mm	1/3 A4 Portrait



A4 Size

1/3 A4 Size

1/3 A4 x 2 Size

Bussiness Card Holder

MATERIAL : Clear	
ARTICLE	DESCRIPTOIN
UMSD009000	Clear
UMSD009B00	Black
UMSD009T00	Turquoise

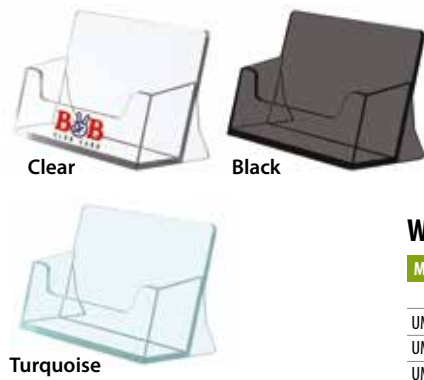

Clear

Black

Turquoise



A4x3 Portrait

1/3 A4x3 Portrait

1/3 A4x4 Portrait

Multiple Pocket

MATERIAL : Clear		
ARTICLE	POSTER	DESCRIPTION
UMSD003000	210 X 297 mm	A4 X 3 Portrait
UMSD003050	100 X 210 mm	1/3 A4 X 4 Portrait
UMSD004000	148 X 210 mm	A5 X 3 Portrait
UMSD005000	100 X 210 mm	1/3 A4 X 3 Portrait

Wall Mount

MATERIAL : Clear		
ARTICLE	POSTER	DESCRIPTION
UMSD008100	210 X 297 mm	A4 Portrait
UMSD007000	148 X 210 mm	A5 Portrait
UMSD006000	100 X 210 mm	1/3 A4 Portrait
UMSD006010	100 X 210 mm	1/3 A4 X 2 Portrait



A4 Size

A5 Size

1/3 A4 X 2 Size



Clear sing holder, Cross Frame allows advertising many messages accepting 8 posters a time. Flat packed Cross Frame saves from space. Rounded corners provides elegant look to Cross Frame. Made of 2 mm clear acrylic.

CROSS FRAME

MATERIAL : Clear acrylic 2 mm		
ARTICLE	POSTER	CAPACITY
UMSCR004A5	148 X 210 mm	4 X A5
UMSCR004A6	105 X 148 mm	4 X A6



4 X A5 Size



Bottom part



Top part



Contemporary poster or photo holder, Tabletop L Frame is suitable for both personal and commercial use. Transparent thick acrylic gets the attention on the poster. Easily portrait or landscape adaptable decorative stands provide a smart finish for Tabletop L Frame. It holds the poster in place firm with magnets.

Table Top L Frame

MATERIAL : Clear acrylic 4 mm		
ARTICLE	POSTER	DESCRIPTION
UMSTTLF00A4	210 X 297 mm	A4 Portrait
UMSTTLF00A5	148 X 210 mm	A5 Portrait
UMSTTLF00A6	105 X 148 mm	A6 Portrait



Stand adaptable landscape or portrait, chrome coated

Clear acrylic

Poster / photo

Clear acrylic



The highly resistant transparent document holders are ideal for the display of menus at restaurants, price lists, etc... These high quality clear brochure holders can be screen printed with a corporate logo. Non-standard sizes can be produced according to customer specification & needs; for printing and quantities, please contact our sales department.

BROCHURE HOLDERS

Clear L Type

MATERIAL : Clear

ARTICLE	POSTER	DESCRIPTION
UMSLD01000	210 X 297 mm	A4 Portrait
UMSLY01000	297 X 210 mm	A4 Landscape
UMSLD02000	148 X 210 mm	A5 Portrait
UMSLY02000	210 X 148 mm	A5 Landscape
UMSLD03000	105 X 148 mm	A6 Portrait
UMSLY03000	148 X 105 mm	A6 Landscape
UMSLD04000	100 X 210 mm	1/3 A4 Portrait
UMSLY04000	210 X 100 mm	1/3 A4 Landscape



A4 Portrait



1/3 A4 Portrait



A5 Landscape



A4 with Front Pocket Landscape

L Type with Front Pocket

MATERIAL : Clear

ARTICLE	POSTER	DESCRIPTION
UMSLDC1000	210 X 297 mm	A4 Portrait
UMSLYC1000	297 X 210 mm	A4 Landscape

Upright

MATERIAL : Clear

ARTICLE	POSTER
UMSDTLDN46	101,6 X 152,4 mm - 4" X 6" inch
UMSDTLDN57	127 X 177,8 mm - 5" X 7" inch
UMSDTLDN81	215,9 X 279,4 mm - 8,5" X 11" inch
UMSDTLDNA6	105 X 148 mm
UMSDTLDNA5	148 X 210 mm
UMSDTLDNA4	210 X 297 mm



A6 Portrait



A5 Portrait



A4 Portrait

Clear T Type

MATERIAL : Clear

ARTICLE	POSTER	DESCRIPTION
UMSTD01000	210 X 297 mm	A4 Portrait
UMSTY01000	297 X 210 mm	A4 Landscape
UMSTD02000	148 X 210 mm	A5 Portrait
UMSTY02000	210 X 148 mm	A5 Landscape
UMSTD03000	105 X 148 mm	A6 Portrait
UMSTY03000	148 X 105 mm	A6 Landscape
UMSTD04000	100 X 210 mm	1/3 A4 Portrait
UMSTY04000	210 X 100 mm	1/3 A4 Landscape



A6 Landscape



A5 Landscape



1/3 A4 Portrait



A4 Portrait

Swing Wing

MATERIAL : Silver anodised aluminium & acrylic

PORTRAIT	LANDSCAPE	POSTER	DESCRIPTION
USWMDNPOA7	USWMYNPOA7	74 X 105 mm	Aluminium base & Acrylic
USWMDNPA43	USWMYNPA43	100 X 210 mm	Aluminium base & Acrylic
USWMDNPOA6	USWMYNPOA6	105 X 148 mm	Aluminium base & Acrylic
USWMDNPOA5	USWMYNPOA5	148 X 210 mm	Aluminium base & Acrylic
USWMDNPOA4	USWMYNPOA4	210 X 297 mm	Aluminium base & Acrylic



1/3 A4 Portrait

Catch thickness min. 1 mm, max. 4 mm.



A5 Landscape



A4 Portrait



A4 Portrait



A5 Portrait



4" X 6" Portrait

Oval

MATERIAL : Clear

ARTICLE	POSTER
UMSDOLDN46	101,6 X 152,4 mm - 4" X 6" inch
UMSDOLDN57	127 X 177,8 mm - 5" X 7" inch
UMSDOLDN81	215,9 X 279,4 mm - 8,5" X 11" inch
UMSDOLDNA5	105 X 148 mm
UMSDOLDNA4	210 X 297 mm



Anti-clear high resistant PET transparent clear document holders. Ideal for the display of menus at the restaurants, price lists, etc... They are suitable for screen printing. Non standard sizes can be produced to customer specification & needs; for printing and quantities please contact our sales executives.

PET POCKET

PET Pocket , no tools required, mount it in less than a minute!

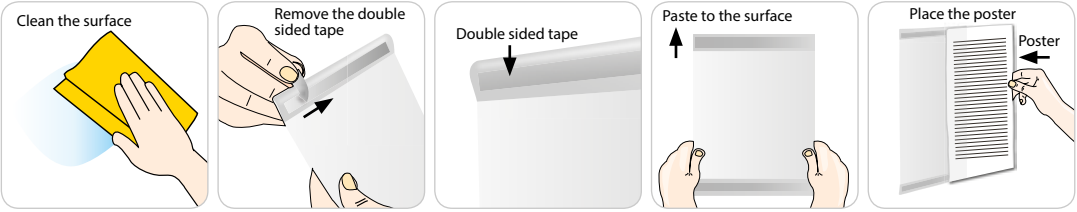

C TYPE : Clear		
ARTICLE	POSTER	DESCRIPTION
UPCC1D00A4	210 X 297 mm	A4 portrait
UPCC1Y00A4	297 X 210 mm	A4 landscape
UPCC1D00A5	148 X 210 mm	A5 portrait
UPCC1Y00A5	210 X 148 mm	A5 landscape
UPCC1D00A6	105 X 148 mm	A6 portrait
UPCC1Y00A6	148 X 105 mm	A6 landscape
UPCC1D00A7	74 X 105 mm	A7 portrait
UPCC1Y00A7	105 X 74 mm	A7 landscape

U TYPE : Clear			
WITHOUT TAPE	WITH TAPE	POSTER	DESCRIPTION
UPCU0D00A4	UPCU1D00A4	210 X 297 mm	A4 portrait
UPCU0Y00A4	UPCU1Y00A4	297 X 210 mm	A4 landscape
UPCU0D00A5	UPCU1D00A5	148 X 210 mm	A5 portrait
UPCU0Y00A5	UPCU1Y00A5	210 X 148 mm	A5 landscape
UPCU0D00A6	UPCU1D00A6	105 X 148 mm	A6 portrait
UPCU0Y00A6	UPCU1Y00A6	148 X 105 mm	A6 landscape
UPCU0D00A7	UPCU1D00A7	74 X 105 mm	A7 portrait
UPCU0Y00A7	UPCU1Y00A7	105 X 74 mm	A7 landscape

D TYPE : Clear		
ARTICLE	POSTER	DESCRIPTION
UPCD1D00A2	420 X 594 mm	A2 portrait
UPCD1Y00A2	594 X 420 mm	A2 landscape
UPCD1D00A3	297 X 420 mm	A3 portrait
UPCD1Y00A3	420 X 297 mm	A3 landscape
UPCD1D00A4	210 X 297 mm	A4 portrait
UPCD1Y00A4	297 X 210 mm	A4 landscape
UPCD1D00A5	148 X 210 mm	A5 portrait
UPCD1Y00A5	210 X 148 mm	A5 landscape
UPCD1D00A6	105 X 148 mm	A6 portrait
UPCD1Y00A6	148 X 105 mm	A6 landscape

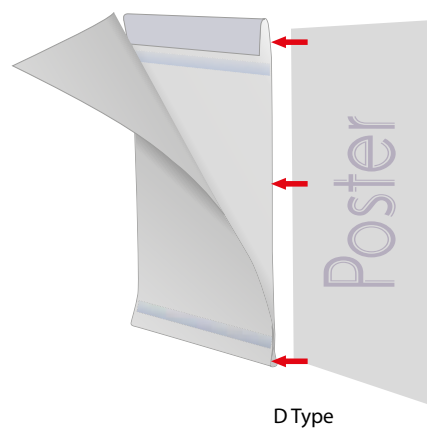
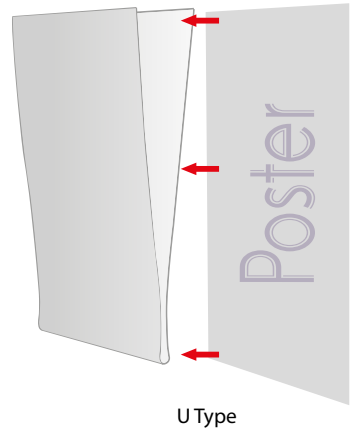
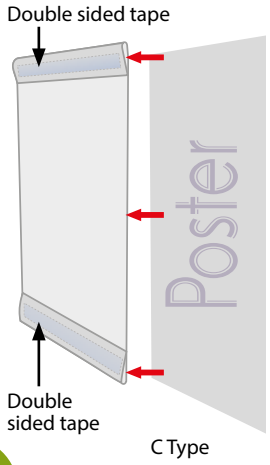



The clear or opaque Tumble boxes are used for voting, collect demands, suggestions or complaints of people in companies, restaurants or offices.. You can chose counter or free standing ones. You can decide If you wish to have ready-to-use or do-it-yourself. Lock system is also enclosed with the product.

TUMBLE BOXES

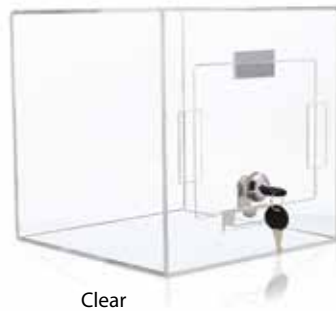

Clear



Opaque

Ready - to - use

Tumble Box

MATERIAL : Acrylic	
ARTICLE	DESCRIPTION
UTBC050000	Clear
UTBC0W0000	Opaque

Do - it - yourself Puzzle

MATERIAL : Acrylic		
ARTICLE	SIZE	DESCRIPTION
UTBPOS0085	215,9 X 279,4 mm	Clear
UTBPOS0012	304,8 X 304,8 mm	Clear
UTBPOS1085	215,9 X 279,4 mm	Clear with header
UTBPOS1012	304,8 X 304,8 mm	Clear with header

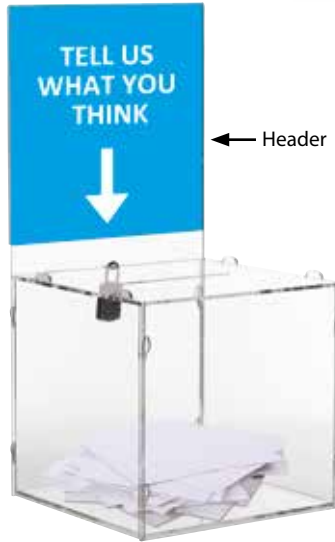

Puzzle Tumble Box with Header

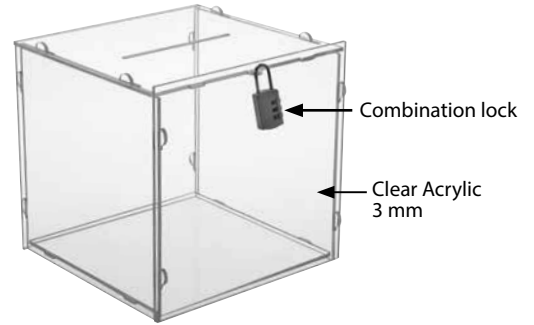

Puzzle Tumble Box



Flat pack

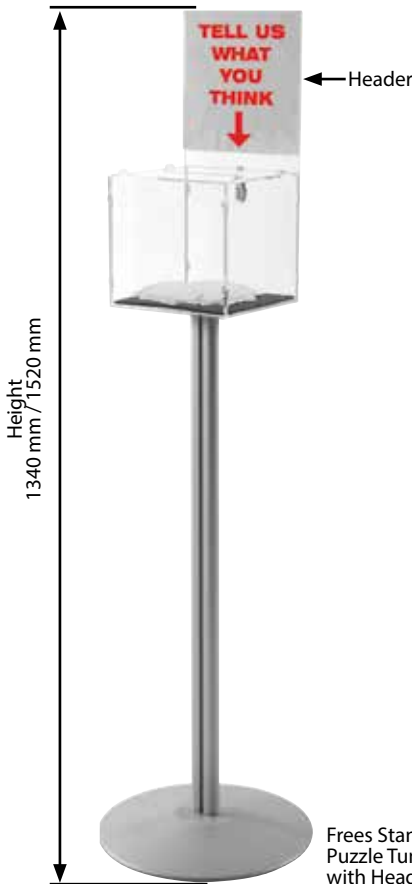

Frees Standing
Puzzle Tumble Box
with Header

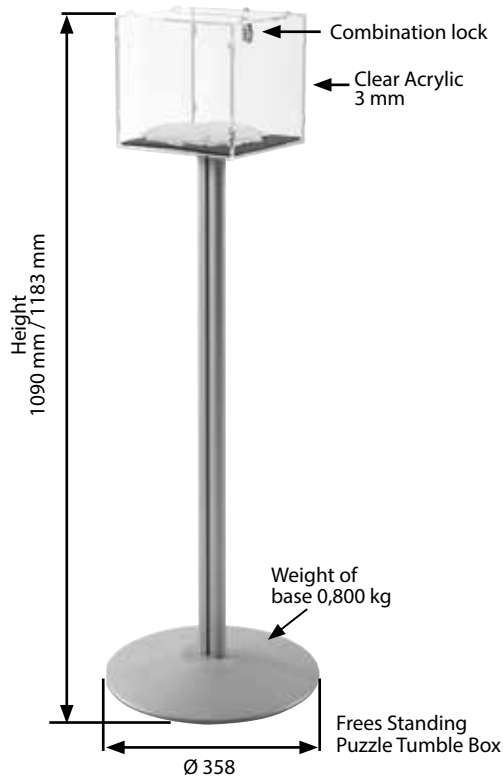

Frees Standing
Puzzle Tumble Box

Do - it - yourself Free Standing Puzzle

MATERIAL : Acrylic			
ARTICLE	SIZE	HEIGHT	DESCRIPTION
UTBP1S0085	215,9 X 279,4 mm	1094 mm	Clear
UTBP1S0012	304,8 X 304,8 mm	1183 mm	Clear
UTBP1S1085	215,9 X 279,4 mm	1340 mm	Clear with header
UTBP1S1012	304,8 X 304,8 mm	1520 mm	Clear with header



Casual style coat hangers are offered in different styles to suit different environments such as offices restaurants, shops or even home use. It helps for tidy work place. Different styles accept clothes, bags, umbrella and accessories.

COAT RACKS

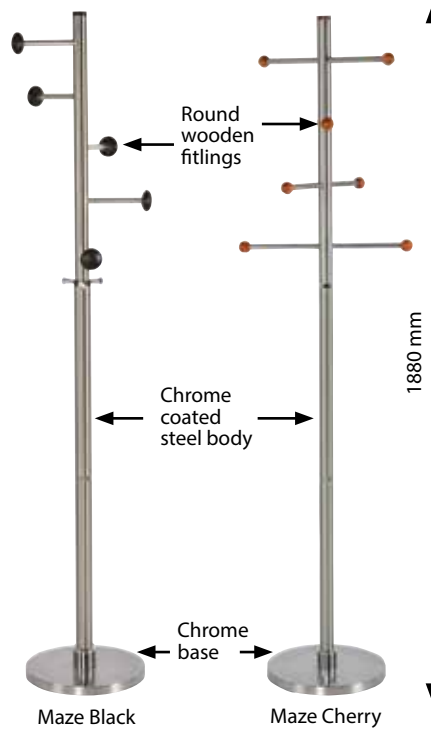

Maze

MATERIAL : Silver		
ARTICLE	SIZE	DESCRIPTION
TXXY801001	490 X 490 X 1880 mm	Cherry
TXXY808A01	350 X 350 X 1880 mm	Black

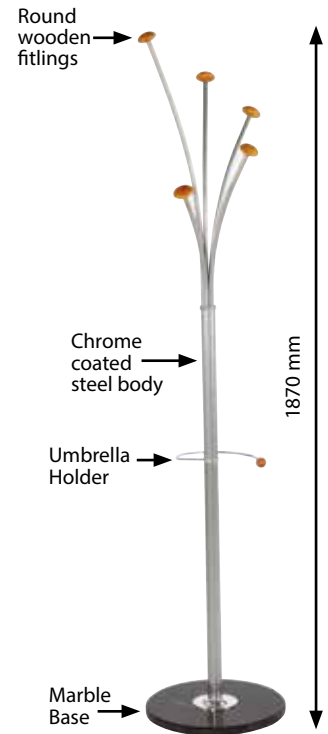

Spring

MATERIAL : Silver		
ARTICLE	SIZE	DESCRIPTION
TWJD856003	380 X 380 X 1870 mm	Silver

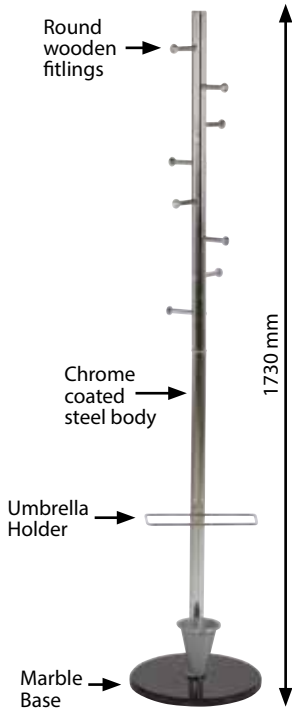

Ladder

MATERIAL : Silver		
ARTICLE	SIZE	DESCRIPTION
TWJD828103	300 X 300 X 1730 mm	Silver

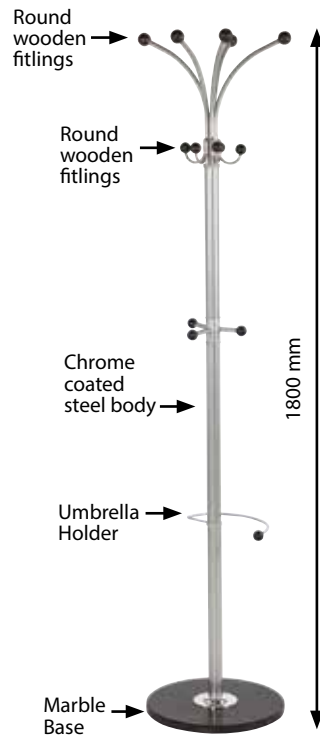

Fountain

MATERIAL : Silver		
ARTICLE	SIZE	DESCRIPTION
TWJD888003	380 X 380 X 1800 mm	Silver



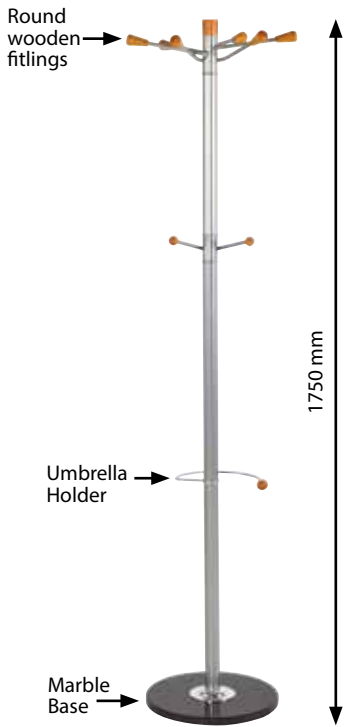

Sunflower

MATERIAL : Silver

ARTICLE	SIZE	DESCRIPTION
TWJD815403	350 X 350 X 1750 mm	Silver

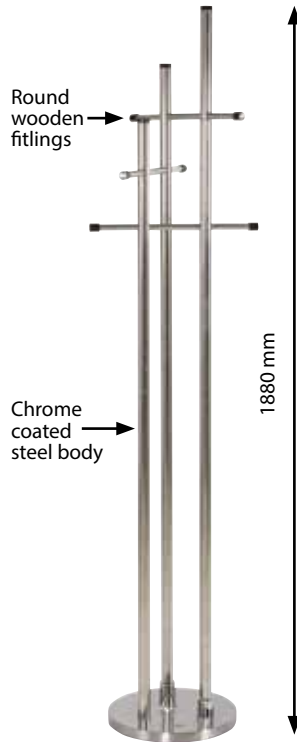

Trio

MATERIAL : Silver

ARTICLE	SIZE	DESCRIPTION
TXXY809A01	450 X 45 X 1880 mm	Silver

- Black knob accessories
- Packaging: single packed
- Easy assembling
- Gross weight: 9,3 kg

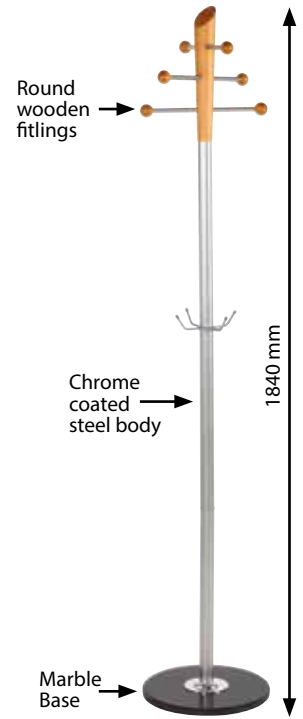

Pine

MATERIAL : Silver

ARTICLE	SIZE	DESCRIPTION
TWJD824403	350 X 350 X 1840 mm	Silver



Coat Hanger Stand

MATERIAL : Silver

ARTICLE	SIZE	DESCRIPTION
TWJD000303	1175 X 440 X 1740 mm	Silver



These commercial rubbish bins are ideal for use in front of office buildings or businesses or even in public areas such as a recreational area, playground or parking lots. You can choose between different styles and capacities to find the best to suit your workplace.

DUST BINS

Flat Pedal

MATERIAL : Stainless Steel

ARTICLE	SIZE (x-y)	DESCRIPTION	CAPACITY
TJIPT90A01	Ø168 X 258 mm	Silver	3 L
TJIPT90B01	Ø205 X 270 mm	Silver	5 L
TJIPT90C01	Ø305 X 450 mm	Silver	20 L



20 L - Stainless Steel



3 L - Stainless Steel



5 L - Stainless Steel

Hotel

MATERIAL : Stainless Steel

ARTICLE	SIZE (x-y)	DESCRIPTION	CAPACITY
TJIHT95A01	Ø205 X 580 mm	Silver	12 L
TJIHT95B01	Ø300 X 605 mm	Silver-with inner bucket	30 L
TJIHT95B02	Ø300 X 605 mm	Black-with inner bucket	30 L



12 L - Stainless Steel



Inner bucket:
zink plated



30 L - Stainless Steel
with inner bucket



30 L - Black powder
coating with inner bucket



18 L Black



18 L Silver



Inner bucket:
zink plated

Hotel Inner Bucket

MATERIAL : Stainless Steel

ARTICLE	SIZE (x-y)	DESCRIPTION	CAPACITY
TJIHT58001	Ø250 X 600 mm	Silver	18 L
TJIHT58002	Ø250 X 600 mm	Black	18 L



Single Wall

MATERIAL : Stainless Steel

ARTICLE	DESCRIPTION
TJIWB93S01	Silver
TJIWB93S02	Black



Mat Finish
Stainless Steel



Black Finish Steel

Double Wall

MATERIAL : Stainless Steel

ARTICLE	DESCRIPTION
TJIWB93D01	Silver
TJIWB93D02	Black



Leather Finish Steel



Mat Finish Stainless Steel



Made of stainless steel, these ashtrays are designed for outdoor use. The lift-out inner bucket makes cleaning this bin easy. With the holes on the base, you can fix them on the ground.

ASHTRAYS

Angled Top Stand-Up

MATERIAL : Stainless Steel

ARTICLE	DESCRIPTION
TJISA26901	Silver

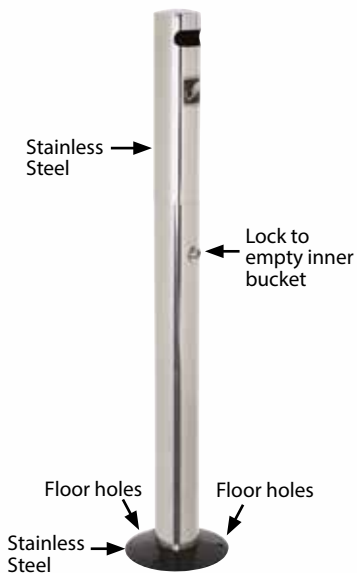
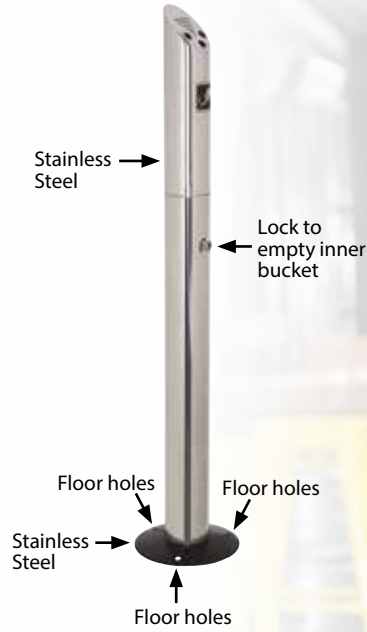

Stand-Up

MATERIAL : Stainless Steel

ARTICLE	DESCRIPTION
TJISA26301	Silver





Stay safe while reaching higher places at office, library, shops or even at home. 2-Step Plastic Stepstool is a tool that can be easily used and available in 4 colors (Black, Red, Blue, Grey) to match your decoration. It tolerates up to 150kg without losing its looks. Can be easily moved around with spring loaded casters. Made from durable PP material.

MATERIAL : PP

ARTICLE	DESCRIPTION
UPSS200001	Black
UPSS200002	Grey
UPSS200003	Red
UPSS200004	Blue



Max. load 150 kg



2-STEP STEPSTOOL

Antislip surface



UPSS200001
Black



UPSS200002
Grey



UPSS200003
Red



UPSS200004
Blue

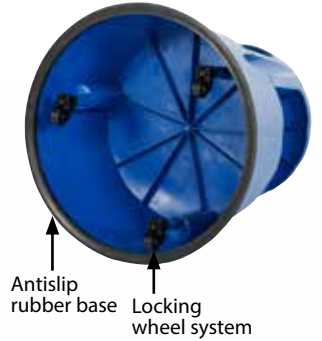

Antislip rubber base

Locking wheel system



RAL Colour Chart



RAL Colour Chart is only for colour reference. Precise RAL colours should be selected from an original & professional chart.

Paper Size

International ISO standard "A"

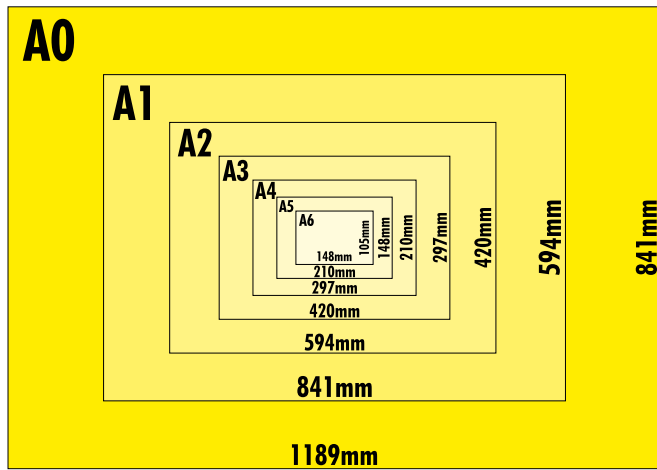

International ISO standard "B"

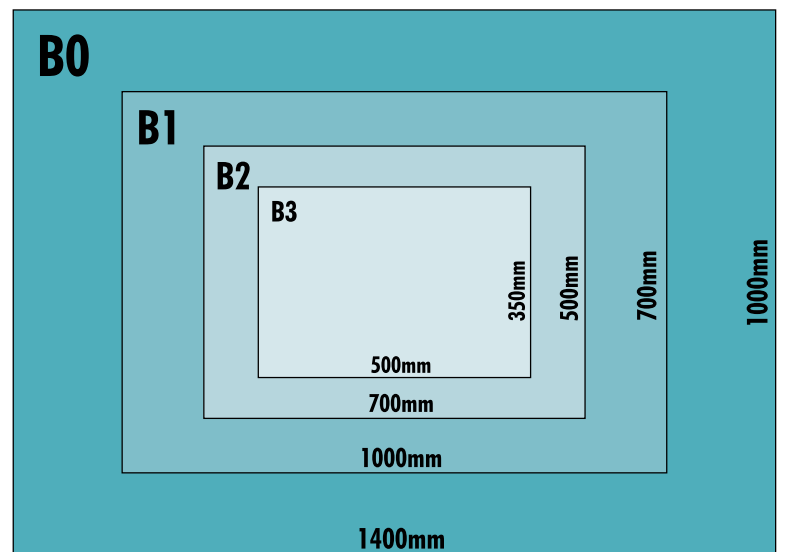

Local standard (for M&T) "F"

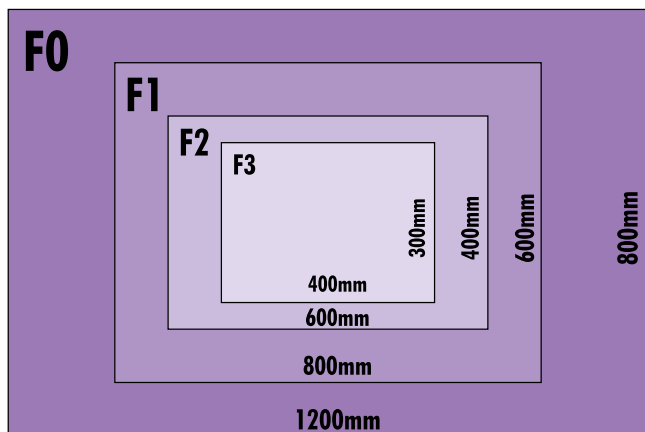



LEYKOM®

supplying suppliers.

www.leykom.ro

